

ROUND & SQUARE COMPOSITE TUFF-POLES®

SPECIFICATIONS MANUAL

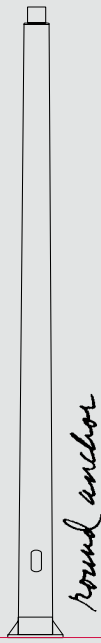

round anchor

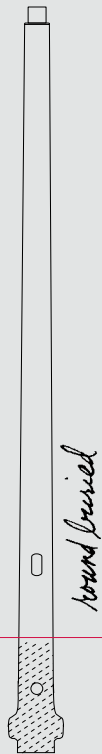

round buried

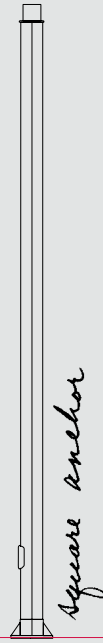

square anchor



square buried

S H A K E S P E A R E
COMPOSITE STRUCTURES

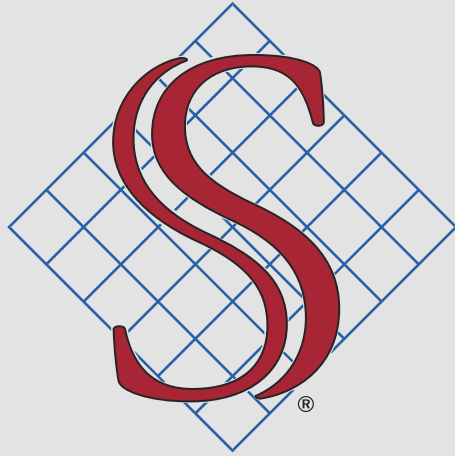

COMPOSITE TUFF-POLE®

Since the 1960s, Shakespeare Composite Structures has pioneered composite pole technologies with design innovations and patented techniques that have revolutionized the entire lighting standard industry. Shakespeare's next-generation fiberglass reinforced composite Tuff-Poles® easily withstand the harshest climates, supporting heavy loads, and resisting high sustained winds, all with minimal maintenance.

Tuff-Poles® are the result of a complete re-engineering and retooling of the manufacturing processes for composite poles, plus advanced, computer-assisted modeling, process monitoring, and controls. The result is a lighter, stronger, better looking pole built to tighter manufacturing tolerances, and employing high-performance coatings for extended UV protection.

Over the years, Shakespeare's engineers and designers have developed an extensive array of styles and features that specifically address commercial, architectural, and roadway applications - from simple yard lights to massive 47-footers capable of withstanding literally hurricane-force winds. Our composite SportsLighting poles can reach 125 feet, supporting enormous lighting assemblies. Shakespeare Composite Structures can supply the composite light poles you want. This Specifications Manual details the features, dimensions, finishes, options, and accessories in our Square and Round Tapered lines.

We make every effort to tailor light poles to our customers' needs, including location of handholes, mounting brackets, colors, finishes, arms, tenons, and accommodation of a variety of luminaires and attachments. With so many choices, it has become impractical to list them all here. If you have a special need, and especially if you're trying to match a Shakespeare composite pole from years past, if you don't find it here, just call.

TABLE OF CONTENTS

The Shakespeare Composite Structures Story	2
The Composite Tuff-Pole® Advantage	4
How to Order (Catalog Numbering)	5
Sample Specification	6
Suggested Installation (Anchor Base)	8
Suggested Installation (Direct Burial)	9
Colors and Finishes	11
Straight Square Poles, Anchor Base	13
Straight Square and Tapered Square Poles	
Direct Burial Base	14
Round Tapered Poles	
Tenon Top Anchor Base and Direct Burial	18
Capped and Tenon Top Anchor Base	20
Capped and Tenon Top Direct Burial	21
Mast Arm Poles	24
Breakaway Poles	42
Mast Arm Breakaway Poles	46
Options and Accessories	
Shrouds and Bolt Covers	64
Mast Arms and Hardware Kits for Mast Arms	65
Side Mount Brackets	66
Tenon Mount and Bullhorn Brackets	67
Composite Burial Foot	68
Tuff-Protector Pole Guard	72

In a hurry?

Our Quick Ship program includes the most frequently ordered pole configurations. Ask for details.

Round Tapered Tuff-Poles®



Round Tapered



Shakespeare
Composite Structures



AA, AB, AC, AD, AG, AH, AO, and AS Series

BA, BB, BC, BD, BG, BH, BO, BS and BX Series

Anchor Base and Direct Burial

Anchor Base

- Mounting heights to 47'
- Natural or smooth finish
- Three standard and five special colors; architectural colors are available. Pigments and UV inhibitors integrated into the resin
- High-performance UV- and weather resistant pigmented polyurethane coating
- Tenon Top (Post Top) or Capped (except AS Series below 25' mounting height)
- EPA ratings are the same for Capped or Tenon Top poles
- Poles can be predrilled for bolt-on side mount fixture(s), arms, etc. (except AS Series below 25' mounting height)
- Composite shrouds (1- or 2-piece) optional. Optional bolt covers available for some styles
- Poles are individually ID tagged
- Wrapped individually for shipment

Direct Burial Base

- Mounting heights to 40'
- Natural or smooth finish
- Three standard and five special colors; architectural colors are available. Pigments and UV inhibitors integrated into the resin
- High-performance UV- and weather resistant pigmented polyurethane coating
- Tenon Top (Post Top) or Capped (except BS Series below 20' mounting height)
- EPA ratings are the same for Capped or Tenon Top poles
- Wiring access hole standard
- Poles can be predrilled for bolt-on side mount fixture(s), arms, etc. (except BS Series below 20' mounting height)
- Poles are individually ID tagged
- Wrapped individually for shipment
- Direct Burial style for fast, easy installation and improved ground line appearance
- Anti-rotation flare structurally integrated into pole base during manufacture
- Shakespeare fiberglass won't rust, rot, or corrode in the ground, and insects won't eat it.
- No concrete foundations or anchor bolts

Page

Tenon Top Poles 19

Capped or Tenon Top 22

■ Standard handhole: 2½" x 5" oval. Optional 4" x 6" or 4" x 12" handholes, depending on pole dimensions. For other handhole options, contact factory. All handhole covers are polyurethane coated to match pole color.

Series:

AA BA
 AB BB
 AC BC
 AD BD
 AG BG
 AH BH
 AO BO
 AS BS
 BX

Shakespeare calculates all EPA recommendations based on poles with handholes, and allowing for a 30% gust factor for all wind ratings, including 120mph.

For applications requiring extremely large loads and extra height, ask for information on Shakespeare Transmission and Distribution poles - up to 70' long - or Shakespeare SportsLighting poles, with mounting heights up to 125' and truly massive capacity.

Round Tapered Composite Tuff-Poles®

Tenon Top

Direct Burial and Anchor Base

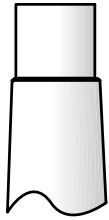

Tenon Top Poles

(AS Series below 25' and BS Series below 20' mounting heights)

TENONS: $2\frac{3}{8}$ ", 3", 4" OD, if pole dimensions permit. Tenons are A356-T6 aluminum or hot-dipped galvanized steel, and are available in all standard sizes; for other optional tenons contact Shakespeare. Post top fixtures, flood lights, or brackets mount with ease.

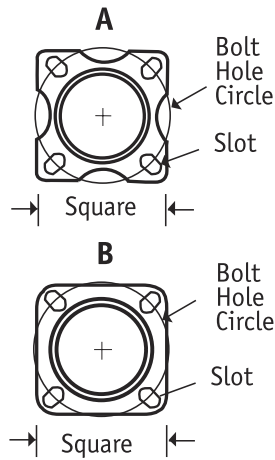

Anchor Base Dimensions

Bolt Hole Circle	Drawing	Square	Slot
8"	A	7.75"	$1\frac{3}{16}$ " x $1\frac{5}{16}$ "
8½"	A	8.125"	$1\frac{3}{16}$ " x $1\frac{5}{16}$ "
9½"	A	8.8"	$1\frac{3}{16}$ " x $1\frac{5}{16}$ "
11½"	B	11"	$1\frac{1}{4}$ " x $1\frac{3}{4}$ "
14"	B	12.9"	$1\frac{1}{2}$ " x 2"
14½"	B	13.3"	$1\frac{1}{2}$ " x 2"
15"	B	13.5"	$1\frac{1}{2}$ " x 2"
15½"	B	14"	$1\frac{1}{2}$ " x 2"

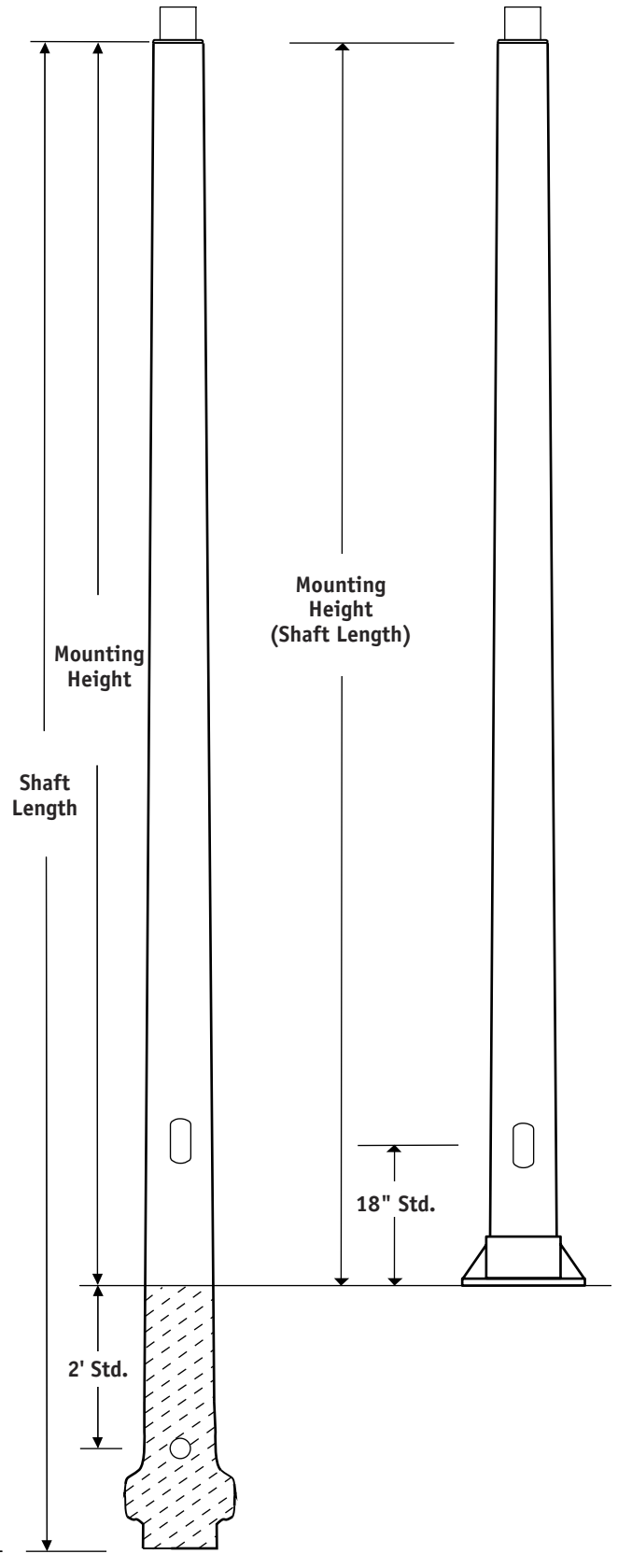

ANCHOR BASE: Cast A356-T6 aluminum, polyurethane coated to match pole color.

Hot dipped galvanized steel anchor bolts complete with nuts (2) and washers (2) are supplied standard ($\frac{5}{8}$ " x 21" x 3", 1" x 30" x 4", or $1\frac{1}{4}$ " x 36" x 6" depending on the pole specified).

Tenon Top Composite Tuff-Poles®

AS and BS Series, Anchor Base and Direct Burial Base
Round Tapered

**COMPOSITE
TUFF-POLE**

Nominal Mounting Height (ft.)	Shaft Length (ft.)	Pole Weight (lbs.)	POLE DIAMETER		Standard Handhole Location from Base (in.)	SUGGESTED MAXIMUM TOTAL LOADING					Bolt Hole Circle (in.)	BASIC CATALOG NUMBER	Comment
			Shaft Top (in.)	Shaft Base (in.)		Total Weight (lbs.)	80 MPH EPA* (sq. ft.)	90 MPH EPA* (sq. ft.)	100 MPH EPA* (sq. ft.)	120 MPH EPA* (sq. ft.)			

Anchor Base, Series AS, Tenon Top

10**	10	22	2.9	4.6	18	150	16.3	12.5	9.9	6.7	8	AS10	Tenon Top only
12**	12	25	2.9	4.9	18	150	13.6	10.3	8.1	5.3	8	AS12	Tenon Top only
14**	14	28	2.9	5.3	18	150	9.8	7.2	5.6	3.6	8	AS14	Tenon Top only
16**	16	30	2.9	5.5	18	100	6.8	4.9	3.7	2.2	8.5	AS16	Tenon Top only
18**	18	34	2.9	5.8	18	100	6.7	4.9	3.8	2.4	8.5	AS18	Tenon Top only
20**	20	44	2.9	6.1	18	100	5.7	4.0	3.1	1.8	8.5	AS20	Tenon Top only
25**	25	52	2.9	6.8	18	100	4.0	2.9	2.1	0.9	9.5	AS25	Tenon Top only

**Not available Capped - do not use AS Series below 25' mounting height for side mount applications, or with tenon mounted arms or for multiple fixture applications - Use A0 Series, instead.

Nominal Mounting Height (ft.)	Shaft Length (ft.)	Pole Weight (lbs.)	POLE DIAMETER		Standard Handhole Location from Base (in.)	SUGGESTED MAXIMUM TOTAL LOADING					Suggested Burial Depth (ft.)	BASIC CATALOG NUMBER	Comment
			Shaft Top (in.)	Shaft Base (in.)		Total Weight (lbs.)	80 MPH EPA* (sq. ft.)	90 MPH EPA* (sq. ft.)	100 MPH EPA* (sq. ft.)	120 MPH EPA* (sq. ft.)			

Direct Burial Base, Series BS, Tenon Top

10**	13	23	2.9	5.0	54	150	16.3	12.5	9.9	6.7	3	BS13	Not available Capped
12**	15	25	2.9	5.3	54	150	10.7	7.9	6.1	4.1	3	BS15	Not available Capped
13**	17	27	2.9	5.6	66	150	10.2	7.6	5.9	3.9	4	BS17	Not available Capped
14**	18	29	2.9	5.7	66	150	9.7	7.1	5.6	3.7	4	BS18	Not available Capped
16**	20	38	2.9	6.1	66	100	7.3	5.3	4.2	2.7	4	BS20	Not available Capped
20**	24	44	2.9	6.6	66	100	6.1	4.6	3.5	2.2	4	BS24	Not available Capped

**Not available Capped - do not use BS Series below 20' mounting height for side mount applications, or with tenon mounted arms or for multiple fixture applications - Use B0 Series, instead.

For capped poles, and poles suitable for side mount or arm mounted fixtures, see Round Tapered Poles. For poles with arms, see Mast Arm Poles.

■ Standard handhole: 2½" x 5" oval. All handhole covers are polyurethane coated to match pole color.

*All EPA recommendations are based on poles with handholes, and include a 30% gust factor for all wind speeds, including 120 mph.

Round Tapered Composite Tuff-Poles®

Tenon Top and Capped
Direct Burial and Anchor Base

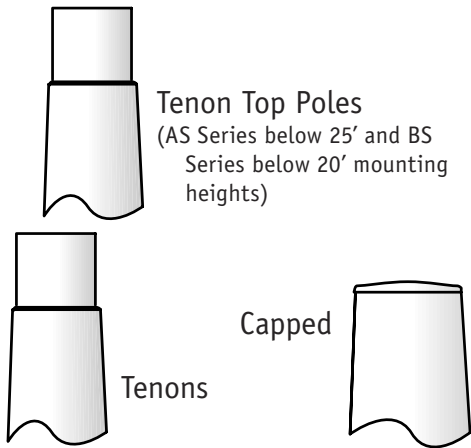

Tenon Top Poles
(AS Series below 25' and BS Series below 20' mounting heights)

Tenons

Capped

TENONS: 2³/₈" , 3" , 4" OD, if pole dimensions permit. Tenons are A356-T6 aluminum or hot-dipped galvanized steel, and are available in all standard sizes; for other optional tenons contact Shakespeare. Post top fixtures, flood lights, or brackets mount with ease.

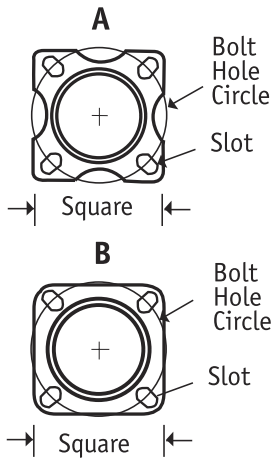

Anchor Base Dimensions

Bolt Hole Circle	Drawing	Square	Slot
8"	A	7.75"	1 ³ / ₁₆ " x 1 ⁵ / ₁₆ "
8 ¹ / ₂ "	A	8.125"	1 ³ / ₁₆ " x 1 ⁵ / ₁₆ "
9 ¹ / ₂ "	A	8.8"	1 ³ / ₁₆ " x 1 ⁵ / ₁₆ "
11 ¹ / ₂ "	B	11"	1 ¹ / ₄ " x 1 ³ / ₄ "
14"	B	12.9"	1 ¹ / ₂ " x 2"
14 ¹ / ₂ "	B	13.3"	1 ¹ / ₂ " x 2"
15"	B	13.5"	1 ¹ / ₂ " x 2"
15 ¹ / ₂ "	B	14"	1 ¹ / ₂ " x 2"

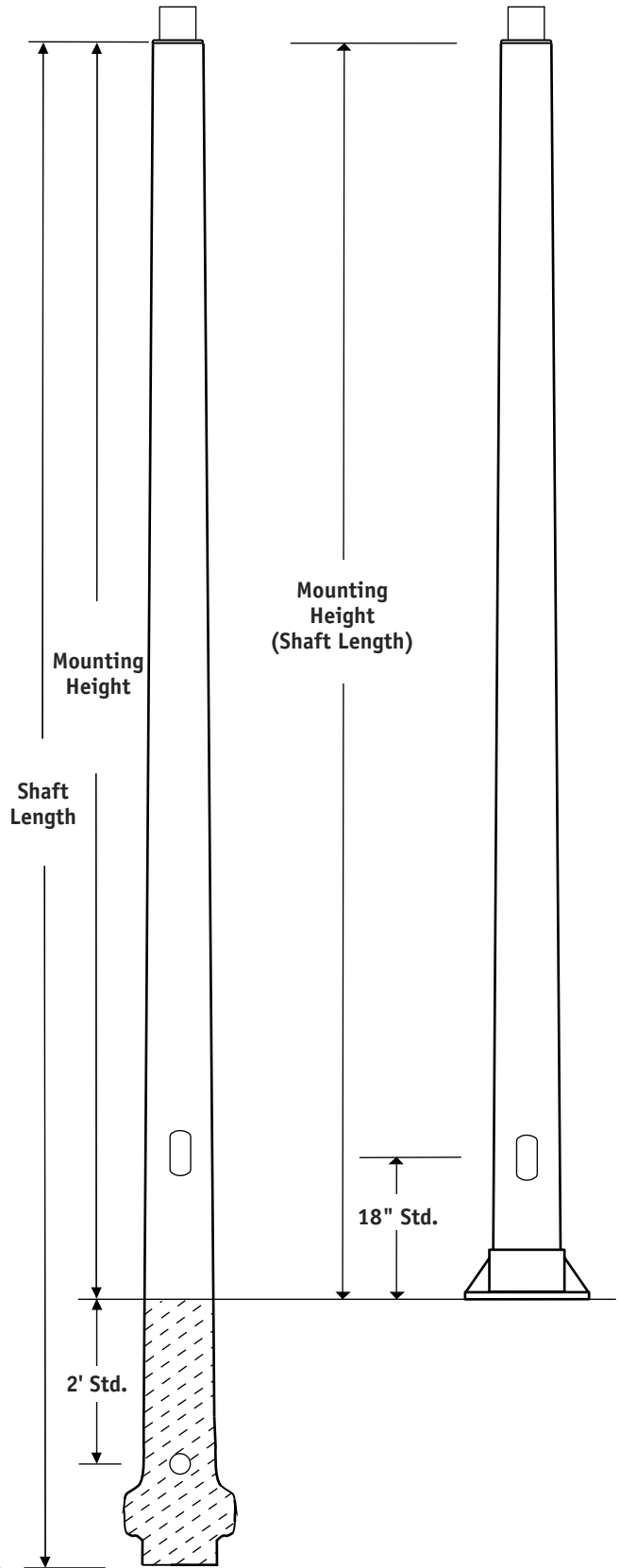
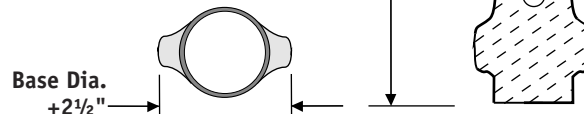

ANCHOR BASE: Cast A356-T6 aluminum, polyurethane coated to match pole color.

Hot dipped galvanized steel anchor bolts complete with nuts (2) and washers (2) are supplied standard (5⁵/₈" x 21" x 3", 1" x 30" x 4", or 1¹/₄" x 36" x 6" depending on the pole specified).

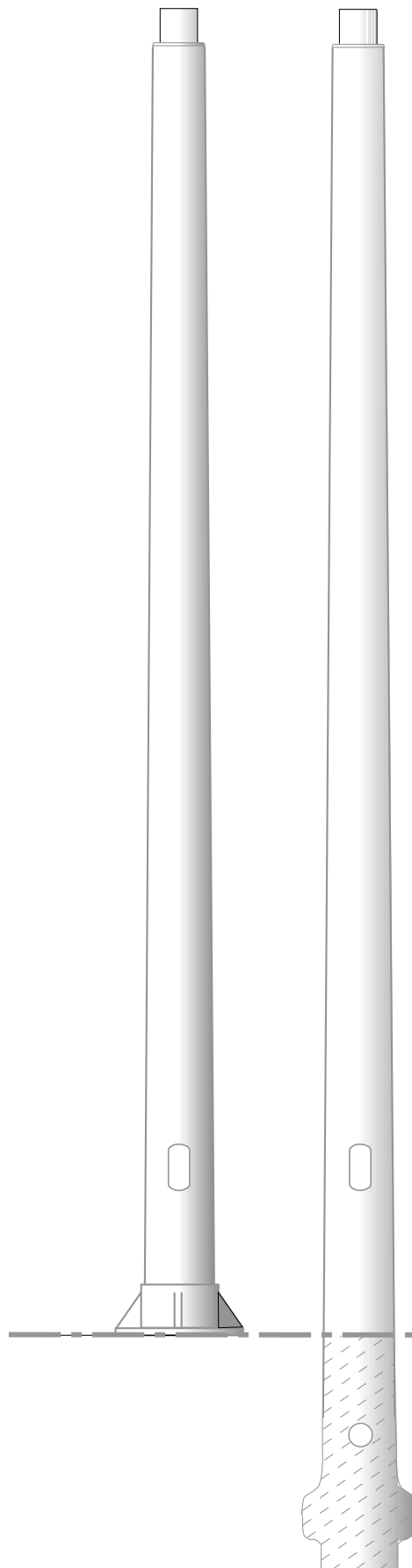

Round Tapered Composite Tuff-Poles®

AA, AB, AC, AD, AG, AH, AO, and AS Series, Anchor Base

Tenon Top or Capped



Nominal Mounting Height (ft.)	Shaft Length (ft.)	Pole Weight (lbs.)	POLE DIAMETER		Standard Handhole Location from Base (in.)	SUGGESTED MAXIMUM TOTAL LOADING					Bolt Hole Circle (in.)	BASIC CATALOG NUMBER	Comment
			Shaft Top (in.)	Shaft Base (in.)		Total Weight (lbs.)	80 MPH EPA* (sq. ft.)	90 MPH EPA* (sq. ft.)	100 MPH EPA* (sq. ft.)	120 MPH EPA* (sq. ft.)			

Anchor Base, Series AA, AB, AC, AD, AG, AH, and AS, Tenon Top or Capped

8	8	20	4.1	5.2	18	150	23.4	18.1	14.4	9.5	8	A08	
10	10	23	4.1	5.4	18	150	19.0	14.6	11.4	7.3	8	A010	
10	10	30	4.4	5.8	18	200	26.1	20.1	15.7	10.1	11.5	AG10	
12	12	28	4.1	5.7	18	150	16.0	12.1	9.3	5.7	8.5	A012	
12	12	34	4.4	6.1	18	200	22.0	16.7	12.8	7.9	11.5	AG12	
14	14	32	4.1	5.9	18	150	14.0	10.4	7.9	4.6	8.5	A014	
14	14	38	4.4	6.4	18	200	19.3	14.3	10.9	6.3	11.5	AG14	
16	16	36	4.1	6.2	18	100	10.0	7.4	5.5	3.0	8.5	A016	
16	16	42	4.4	6.6	18	150	13.8	10.2	7.6	4.1	11.5	AG16	
18	18	41	4.1	6.5	18	100	9.0	6.5	4.8	2.4	9.5	A018	
18	18	46	4.4	6.9	18	150	12.4	9.0	6.6	3.3	11.5	AG18	
20	20	45	4.1	6.7	18	100	8.2	5.8	4.1	1.9	9.5	A020	
20	20	49	4.4	7.1	18	150	11.3	8.0	5.6	2.6	11.5	AG20	
20	20	62	4.6	7.3	18	200	14.4	11.1	8.9	5.9	11.5	AH20	
25	25	55	4.1	6.8	18	100	5.4	3.4	2.0	--	9.5	A025	
25	25	56	4.4	7.1	18	150	7.4	4.7	2.8	--	11.5	AG25	
25	25	75	4.6	7.3	18	200	9.6	7.3	5.7	3.4	11.5	AH25	
25	25	109	6.2	9.5	18	300	14.9	11.5	9.0	5.4	14	AA25	
25	25	142	6.4	9.6	18	300	23.2	18.2	14.3	9.0	14	AB25	
30	30	106	4.7	8.4	18	100	11.2	8.5	6.7	4.5	11.5	AS30	
30	30	140	4.9	8.5	18	200	15.6	12.0	9.5	6.0	11.5	AH30	
30	30	174	6.4	10.3	18	300	19.7	15.2	11.7	7.1	14.5	AB30	
30	30	202	6.6	10.4	18	300	28.7	22.4	17.4	11.0	14.5	AC30	
30	30	243	6.9	10.6	18	300	37.4	29.1	22.9	14.8	14.5	AD30	
35	35	125	4.7	8.4	18	100	5.5	3.8	2.7	1.3	11.5	AS35	
35	35	161	4.9	8.5	18	200	8.5	6.2	4.7	2.6	11.5	AH35	
35	35	201	6.4	11.0	18	300	14.3	10.8	7.8	4.0	15	AB35	
35	35	248	6.6	11.1	18	300	21.8	16.6	12.5	7.2	15	AC35	
35	35	282	6.9	11.3	18	300	29.0	22.1	17.0	10.3	15	AD35	
40	40	165	6.2	11.6	18	300	6.4	4.3	2.4	--	15.5	AA40	
40	40	227	6.4	11.7	18	300	12.2	8.8	6.0	2.5	15.5	AB40	
40	40	263	6.6	11.8	18	300	19.2	14.1	10.4	5.4	15.5	AC40	
40	40	317	6.9	11.9	18	300	25.8	19.3	14.3	8.3	15.5	AD40	
45	45	183	6.2	11.7	18	300	3.9	2.2	0.6	--	15.5	AA45	
45	45	254	6.4	11.8	18	300	9.1	6.2	3.8	0.6	15.5	AB45	
45	45	295	6.6	11.9	18	300	15.2	10.9	7.6	3.2	15.5	AC45	
45	45	375	6.9	12.0	18	300	21.2	15.4	11.2	5.7	15.5	AD45	

■ Standard handhole: 2½" x 5" oval. All handhole covers are polyurethane coated to match pole color. ■ EPA ratings are the same for capped or tenon top poles. ■ Poles can be predrilled for bolt-on side mount fixture(s), arms, brackets, etc. ■ All poles are individually wrapped for shipment.

*All EPA recommendations are based on poles with handholes, and include a 30% gust factor for all wind speeds, including 120 mph.

Round Tapered Composite Tuff-Poles®

BA, BB, BC, BD, BG, BH, B0, BS, and BX Series, Direct Burial Base

Tenon Top or Capped

**COMPOSITE
TUFF-POLE**

Nominal Mounting Height (ft.)	Shaft Length (ft.)	Pole Weight (lbs.)	POLE DIAMETER		Standard Handhole Location from Base (in.)	SUGGESTED MAXIMUM TOTAL LOADING					Suggested Burial Depth (ft.)	BASIC CATALOG NUMBER	Comment
			Shaft Top (in.)	Shaft Base (in.)		Total Weight (lbs.)	80 MPH EPA* (sq. ft.)	90 MPH EPA* (sq. ft.)	100 MPH EPA* (sq. ft.)	120 MPH EPA* (sq. ft.)			
Direct Burial Base, Series BA, BB, BC, BD, BG, BH, and BS, Tenon Top or Capped													
8	11	21	4.1	5.5	54	150	23.4	18.1	14.4	9.5	3	B011	
10	13	24	4.1	5.8	54	150	19.0	14.6	11.4	7.3	3	B013	
10	13	27	4.4	6.2	54	200	26.1	20.1	15.7	10.1	3	BG13	
12	15	28	4.1	6.1	54	150	16.0	12.1	9.3	5.7	3	B015	
12	15	31	4.4	6.6	54	200	22.0	16.7	12.8	7.9	3	BG15	
14	18	34	4.1	6.5	66	150	14.0	10.4	7.9	4.6	4	B018	
14	18	38	4.4	6.9	66	200	19.3	14.3	10.9	6.3	4	BG18	
16	20	38	4.1	6.7	66	100	10.0	7.4	5.5	3.0	4	B020	
16	20	42	4.4	7.1	66	150	13.8	10.2	7.6	4.1	4	BG20	
16	20	52	4.6	7.3	66	200	16.2	12.6	10.1	6.7	4	BH20	
18	22	42	4.1	6.7	66	100	9.0	6.5	4.8	2.4	4	B022	
18	22	46	4.4	7.1	66	150	12.4	9.0	6.6	3.3	4	BG22	
20	24	46	4.1	6.7	66	100	8.2	5.8	4.1	1.9	4	B024	
20	24	50	4.4	7.1	66	150	10.4	8.0	5.6	2.6	4	BG24	
20	24	62	4.6	7.3	66	200	11.2	8.6	6.8	4.5	4	BH24	
25	30	71	4.5	8.2	78	100	6.2	4.7	3.6	2.2	5	BS30	
25	30	98	4.7	8.4	78	200	14.5	11.2	8.9	5.9	5	BH30	
25	30	132	4.9	8.5	78	300	20.1	15.7	12.5	8.2	5	BX30	
25	30	159	6.4	10.3	78	300	23.2	18.2	14.3	9.0	5	BB30	
25	30	187	6.6	10.4	78	300	33.5	26.2	20.8	13.6	5	BC30	
30	35	82	4.5	8.3	78	100	3.7	2.6	1.9	0.8	5	BS35	
30	35	116	4.7	8.4	78	200	10.5	8.0	6.2	3.8	5	BH35	
30	35	153	4.9	8.5	78	300	14.8	11.4	9.0	5.6	5	BX35	
30	35	186	6.4	11.0	78	300	19.7	16.2	11.7	7.1	5	BB35	
30	35	218	6.6	11.1	78	300	28.7	22.4	17.4	11.0	5	BC35	
30	35	266	6.9	11.3	78	300	37.4	29.1	22.9	14.8	5	BD35	
35	41	154	6.2	11.7	90	300	8.1	6.0	3.9	1.3	6	BA41	
35	41	218	6.4	11.8	90	300	14.3	10.8	7.8	4.0	6	BB41	
35	41	156	6.6	11.9	90	300	21.8	16.6	12.5	7.2	6	BC41	
35	41	311	6.9	12.0	90	300	29.0	22.1	17.5	10.3	6	BD41	
40	47	176	6.2	11.7	102	300	6.4	4.3	2.4	--	7	BA47	
40	47	249	6.4	11.8	102	300	12.2	8.8	6.0	2.5	7	BB47	
40	47	292	6.6	11.9	102	300	19.2	14.1	10.4	5.4	7	BC47	
40	47	357	6.9	12.0	102	300	25.8	19.3	14.5	6.3	7	BD47	

■ Standard handhole: 2½" x 5" oval. All handhole covers are polyurethane coated to match pole color. ■ EPA ratings are the same for capped or tenon top poles. ■ Poles can be predrilled for bolt-on side mount fixture(s), arms, brackets, etc. ■ All poles are individually wrapped for shipment.

*All EPA recommendations are based on poles with handholes, and include a 30% gust factor for all wind speeds, including 120 mph.



Notes:

Round Tapered Tuff-Poles® with Mast Arms



Round Tapered + Arms



AA, AB, AC, AD, AG, AH, AO, and AS Series

BA, BB, BC, BD, BG, BH, BO, BS and BX Series

Anchor Base and Direct Burial

Anchor Base

- Mounting heights to 45'
- Natural or smooth finish
- Three standard and five special colors; architectural colors are available. Pigments and UV inhibitors integrated into the resin
- High-performance UV- and weather resistant pigmented polyurethane coating
- Capped
- Poles are predrilled for Shakespeare Mast Arms
- Composite shrouds (1- or 2-piece) optional. Optional bolt covers available for some styles
- Poles are individually ID tagged
- Wrapped individually for shipment
- Standard handhole: 2½" x 5" oval. Optional 4" x 6", 3" x 9", or 4" x 12" handholes, depending on pole dimensions. For other handhole options, contact factory. All handhole covers are polyurethane coated to match pole color.

Direct Burial Base

- Mounting heights to 40'
- Natural or smooth finish
- Three standard and five special colors; architectural colors are available. Pigments and UV inhibitors integrated into the resin
- High-performance UV- and weather resistant pigmented polyurethane coating
- Capped
- Poles are predrilled for Shakespeare Mast Arms
- Wiring access hole standard
- Poles are individually ID tagged
- Wrapped individually for shipment
- Direct Burial style for fast, easy installation and improved ground line appearance
- Anti-rotation flare structurally integrated into pole base during manufacture
- Shakespeare fiberglass won't rust, rot, or corrode in the ground, and insects won't eat it.
- No concrete foundations or anchor bolts

Capped

Page

Poles with:	
4' Mast Arms	28
6' Mast Arms	30
8' Mast Arms	32
10' Mast Arms	36
12' Mast Arms	38
15' Truss Arms	48

Shakespeare calculates all EPA recommendations based on poles with handholes, allowing for a 30% gust factor for all wind ratings, including 120mph.



Series: _____

- | | |
|----|----|
| AA | BA |
| AB | BB |
| AC | BC |
| AD | BD |
| AG | BG |
| AH | BH |
| AO | BO |
| AS | BS |
| | BX |

Mast Arm Composite Tuff-Poles®

Anchor Base and Direct Burial Base
One to Four Shakespeare Mast Arms

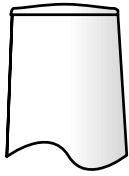

Capped

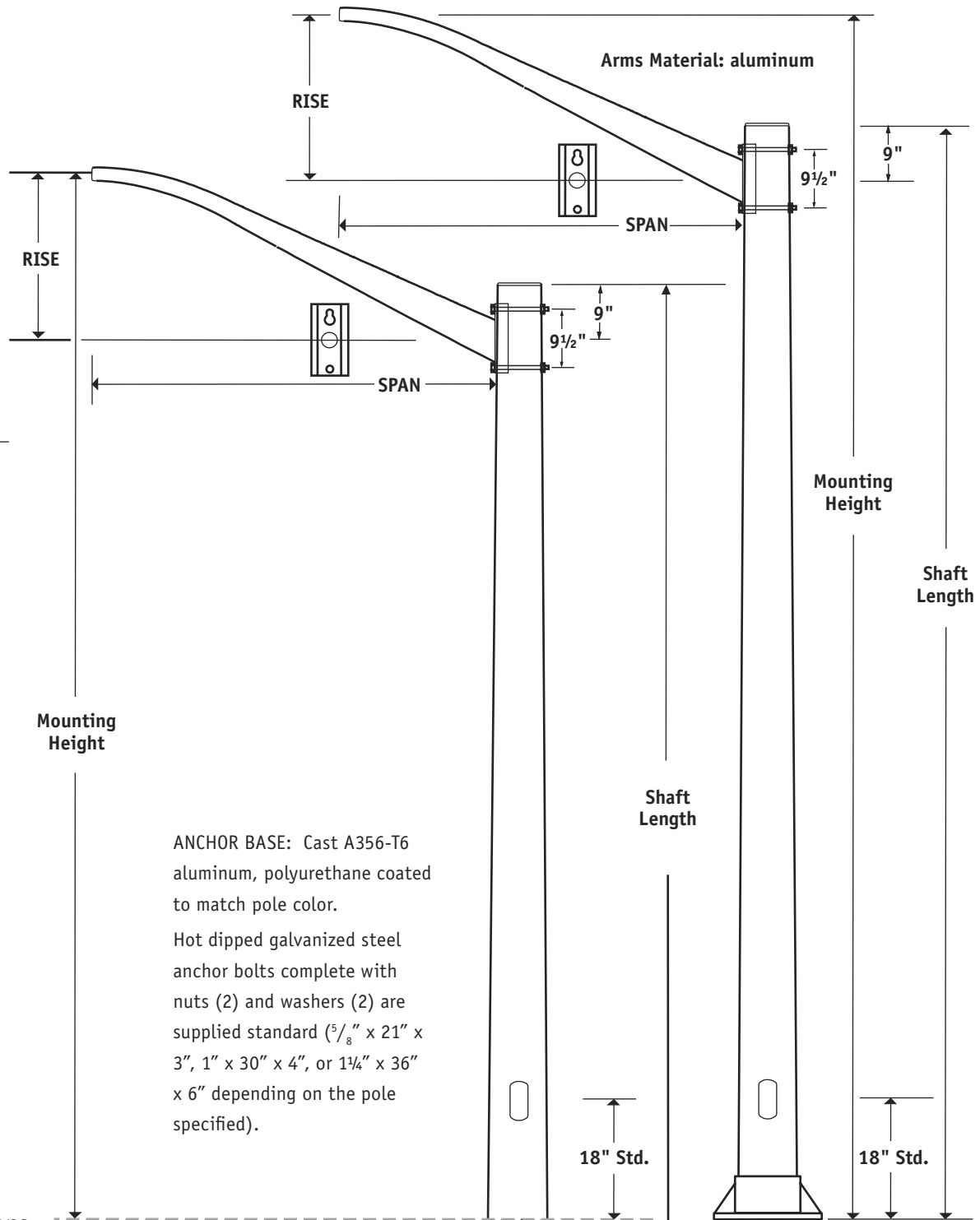

Arm Dimensions

Arm Length	SPAN	RISE
4'	45"	15"
6'	68"	24"
8'	90"	33"
10'	120"	39"
12'	138"	45"
15'	174"	45"

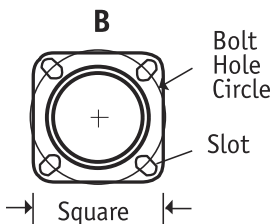
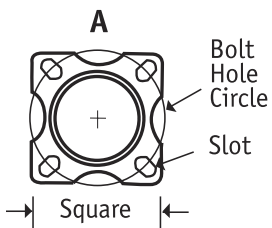

ANCHOR BASE: Cast A356-T6 aluminum, polyurethane coated to match pole color.

Hot dipped galvanized steel anchor bolts complete with nuts (2) and washers (2) are supplied standard (5/8" x 21" x 3", 1" x 30" x 4", or 1 1/4" x 36" x 6" depending on the pole specified).

Anchor Base Dimensions

Bolt Hole Circle	Drawing	Square	Slot
8 1/2"	A	8.125"	13/16" x 1 5/16"
9 1/2"	A	8.8"	13/16" x 1 5/16"
11 1/2"	B	11"	1 1/4" x 1 3/4"
14"	B	12.9"	1 1/2" x 2"
14 1/2"	B	13.3"	1 1/2" x 2"
15"	B	13.5"	1 1/2" x 2"
15 1/2"	B	14"	1 1/2" x 2"

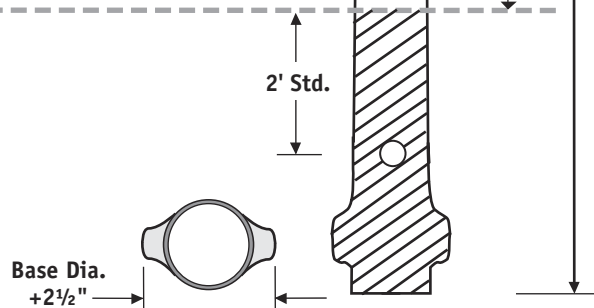

Notes:

Poles are not rated above 3.2 EPA because the mast arms are not rated for luminaires greater than 3.2 EPA each. EPA and weight specifications *include* the arm(s). All EPA recommendations, *including 120 mph*, are calculated to include a 30% gust factor

4' Mast Arm Round Tapered Composite Tuff-Poles®

AA, AB, AC, AG, AH, AO, and AS Series, Anchor Base

One or Two Shakespeare 4-foot Mast Arms



Nominal Mounting Height (ft.)	Shaft Length (ft.)	Pole Weight (lbs.)	POLE DIAMETER		Standard Handhole Location from Base (in.)	SUGGESTED MAXIMUM TOTAL LOADING PER ARM					Bolt Hole Circle (in.)	BASIC CATALOG NUMBER	Comment
			Shaft Top (in.)	Shaft Base (in.)		Total Weight (lbs.)	80 MPH EPA* (sq. ft.)	90 MPH EPA* (sq. ft.)	100 MPH EPA* (sq. ft.)	120 MPH EPA* (sq. ft.)			
Anchor Base pole with ONE 4-foot Mast Arm													
16	16	41	4.1	6.2	18	75	3.2*	3.2*	3.2*	2.9	8.5	AO16-10	Arm: OPAR-4x4
18	18	46	4.1	6.5	18	75	3.2*	3.2*	3.2*	2.3	9.5	AO18-10	Arm: OPAR-4x4
20	20	50	4.1	6.7	18	75	3.2*	3.2*	3.2*	1.8	9.5	AO20-10	Arm: OPAR-4x4
20	20	59	4.4	7.1	18	75	3.2*	3.2*	3.2*	1.9	11.5	AG20-10	Arm: OPAR-4
25	25	63	4.1	6.8	18	75	3.2*	2.3	1.4	0.4	9.5	AO25-10	Arm: OPAR-4x4
25	25	66	4.4	7.1	18	75	3.2*	2.5	1.6	0.6	11.5	AG25-10	Arm: OPAR-4
25	24.5	79	4.6	7.3	18	75	3.2*	3.2*	3.2*	2.2	11.5	AH25-14	Arm: OPAR-4
30	29.5	111	4.7	8.4	18	75	3.2*	3.2*	3.2*	3.2*	11.5	AS30-14	Arm: OPAR-4
35	34.5	131	4.7	8.4	18	75	3.2*	3.2*	2.7	1.2	11.5	AS35-14	Arm: OPAR-4
40	39.5	175	6.2	11.5	18	75	3.2*	3.2*	2.4	--	15.5	AA40-14	Arm: OPAR-4x6
40	39.5	237	6.4	11.6	18	75	3.2*	3.2*	3.2*	2.1	15.5	AB40-14	Arm: OPAR-4x6
45	44.5	202	6.2	11.7	18	75	3.2*	3.2*	0.6	--	15.5	AA45-14	Arm: OPAR-4x6
45	44.5	270	6.4	11.8	18	75	3.2*	3.2*	3.2*	0.4	15.5	AB45-14	Arm: OPAR-4x6
Anchor Base pole with TWO 4-foot Mast Arms @180°													
16	16	47	4.1	6.2	18	75	3.2*	2.7	1.9	0.9	8.5	AO16-20	Arms: 2@ OPAR-4x4
18	18	52	4.1	6.5	18	75	3.2*	2.2	1.5	0.6	9.5	AO18-20	Arms: 2@ OPAR-4x4
20	20	56	4.1	6.7	18	75	2.8	1.8	1.2	0.4	9.5	AO20-20	Arms: 2@ OPAR-4x4
20	19.5	71	4.6	7.3	18	75	3.2*	3.2*	2.7	1.6	11.5	AH20-24	Arms: 2@ OPAR-4
20	20	65	4.4	7.1	18	75	3.0	2.0	1.4	0.6	11.5	AG20-20	Arms: 2@ OPAR-4
25	24.5	88	4.6	6.7	18	75	3.0	2.1	1.4	0.6	11.5	AH25-24	Arms: 2@ OPAR-4
25	24.5	121	6.2	7.3	18	75	3.2*	3.2*	3.2*	2.0	14	AA25-24	Arms: 2@ OPAR-4x6
30	29.5	117	4.7	7.3	18	75	3.2*	3.2*	2.6	1.4	11.5	AS30-24	Arms: 2@ OPAR-4
30	29.5	144	4.9	9.4	18	75	3.2*	3.2*	3.2*	2.4	11.5	AH30-24	Arms: 2@ OPAR-4
35	34.5	137	4.7	8.4	18	75	2.2	1.4	0.8	--	11.5	AS35-24	Arms: 2@ OPAR-4
35	34.5	164	4.9	8.5	18	75	3.2*	2.8	1.9	0.8	11.5	AH35-24	Arms: 2@ OPAR-4
35	34.5	214	6.4	11.0	18	75	3.2*	3.2*	3.2*	1.3	15	AB35-24	Arms: 2@ OPAR-4x6
40	39.5	182	6.2	11.5	18	75	2.7	1.6	0.6	--	15.5	AA40-24	Arms: 2@ OPAR-4x6
40	39.5	244	6.4	11.6	18	75	3.2*	3.2*	2.4	0.5	15.5	AB40-24	Arms: 2@ OPAR-4x6
40	39.5	281	6.6	11.7	18	75	3.2*	3.2*	3.2*	2.0	15.5	AC40-24	Arms: 2@ OPAR-4x6
45	44.5	286	6.4	11.8	18	75	3.2*	2.5	1.3	--	15.5	AB45-24	Arms: 2@ OPAR-4x6
45	44.5	315	6.6	11.9	18	75	3.2*	3.2*	3.2*	0.9	15.5	AC45-24	Arms: 2@ OPAR-4x6

■ Standard handhole: 2½" x 5" oval. Handhole covers are polyurethane coated to match pole color. ■ All poles are individually wrapped for shipment. ■ Poles on this page are predrilled for Shakespeare 4' Mast Arms ■ Aluminum cap standard.

*Poles are not rated above 3.2 EPA because the mast arms are not rated for luminaires greater than 3.2 EPA each. EPA and weight specifications include the arm(s). All EPA recommendations are based on poles with handholes, and include a 30% gust factor.

4' Mast Arm Round Tapered Composite Tuff-Poles®

BA, BB, BC, BG, BH, B0, BS, and BX Series, Direct Burial Base

One or Two Shakespeare 4-foot Mast Arms

**COMPOSITE
TUFF-POLE**

Nominal Mounting Height (ft.)	Shaft Length (ft.)	Pole Weight (lbs.)	POLE DIAMETER		Standard Handhole Location from Base (in.)	SUGGESTED MAXIMUM TOTAL LOADING PER ARM					Suggested Burial Depth (ft.)	BASIC CATALOG NUMBER	Comment
			Shaft Top (in.)	Shaft Base (in.)		Total Weight (lbs.)	80 MPH EPA* (sq. ft.)	90 MPH EPA* (sq. ft.)	100 MPH EPA* (sq. ft.)	120 MPH EPA* (sq. ft.)			
Direct Burial Base pole with ONE 4-foot Mast Arm													
16	20	44	4.1	6.7	66	75	3.2*	3.2*	3.2*	2.9	4	B020-10	Arm: OPAR-4x4
18	22	49	4.1	6.7	66	75	3.2*	3.2*	3.2*	2.3	4	B022-10	Arm: OPAR-4x4
20	24	54	4.1	6.8	66	75	3.2*	3.2*	3.2*	1.8	4	B024-10	Arm: OPAR-4x4
25	29.5	77	4.5	8.2	78	75	3.2*	3.2*	2.9	1.5	5	BS30-14	Arm: OPAR-4
30	34.5	88	4.5	8.3	78	75	3.1	1.9	1.2	--	5	BS35-14	Arm: OPAR-4
30	34.5	122	4.7	8.4	78	75	3.2*	3.2*	3.2*	3.2*	5	BH35-14	Arm: OPAR-4
35	40.5	158	6.2	11.6	90	75	3.2*	3.2*	3.2*	1.0	6	BA41-14	Arm: OPAR-4x6
40	46.5	180	6.2	11.7	102	75	3.2*	3.2*	2.4	--	7	BA47-14	Arm: OPAR-4x6
40	46.5	253	6.4	11.8	102	75	3.2*	3.2*	3.2*	2.1	7	BB47-14	Arm: OPAR-4x6
Direct Burial Base pole with TWO 4-foot Mast Arms @180°													
16	20	49	4.1	6.7	66	75	3.2*	2.7	1.9	0.9	4	B020-20	Arms: 2@ OPAR-4x4
16	20	54	4.4	7.1	66	75	3.2*	2.9	2.1	1.1	4	BG20-20	Arms: 2@ OPAR-4
18	22	54	4.1	6.7	66	75	3.2*	2.2	1.5	0.6	4	B022-20	Arms: 2@ OPAR-4x4
18	22	58	4.4	7.1	66	75	3.2*	2.4	1.5	0.8	4	BG22-20	Arms: 2@ OPAR-4
20	24	59	4.1	6.8	66	75	2.8	1.8	1.2	0.4	4	B024-20	Arms: 2@ OPAR-4x4
20	24	62	4.4	7.1	66	75	3.0	2.0	1.4	0.6	4	BG24-20	Arms: 2@ OPAR-4
20	23.5	70	4.6	7.3	66	75	3.2*	3.2*	2.7	1.6	4	BH24-24	Arms: 2@ OPAR-4
25	29.5	82	4.5	8.2	78	75	2.2	1.4	0.9	--	5	BS30-24	Arms: 2@ OPAR-4
25	29.5	109	4.7	8.4	78	75	3.2*	3.2*	3.2*	2.2	5	BH30-24	Arms: 2@ OPAR-4
30	34.5	128	4.7	8.4	78	75	3.2*	3.2*	1.4	1.4	5	BH35-24	Arms: 2@ OPAR-4
30	34.5	156	4.9	8.5	78	75	3.2*	3.2*	3.2*	2.4	5	BX35-24	Arms: 2@ OPAR-4
35	40.5	163	6.2	11.6	90	75	2.2	2.4	1.4	--	6	BA41-24	Arms: 2@ OPAR-4x6
35	40.5	226	6.4	11.7	90	75	3.2*	3.2*	3.2*	1.3	6	BB41-24	Arms: 2@ OPAR-4x6
40	46.5	186	6.2	11.7	102	75	2.7	1.6	0.6	--	7	BA47-24	Arms: 2@ OPAR-4x6
40	46.5	258	6.4	11.8	102	75	3.2*	3.2*	2.4	0.5	7	BB47-24	Arms: 2@ OPAR-4x6
40	46.5	300	6.6	11.9	102	75	3.2*	3.2*	3.2*	2.0	7	BC47-24	Arms: 2@ OPAR-4x6

■ Standard handhole: 2½" x 5" oval. Handhole covers are polyurethane coated to match pole color. ■ All poles are individually wrapped for shipment. ■ Poles on this page are predrilled for Shakespeare 4' Mast Arms. ■ Aluminum cap and wiring access hole standard. *Poles are not rated above 3.2 EPA because the mast arms are not rated for luminaires greater than 3.2 EPA each. EPA and weight specifications include the arm(s). All EPA recommendations are based on poles with handholes, and include a 30% gust factor.

6' Mast Arm Round Tapered Composite Tuff-Poles®

AA, AB, AC, AD, AG, AH, AO, and AS Series, Anchor Base

One, Two or Four Shakespeare 6-foot Mast Arms



Nominal Mounting Height (ft.)	Shaft Length (ft.)	Pole Weight (lbs.)	POLE DIAMETER		Standard Handhole Location from Base (in.)	SUGGESTED MAXIMUM TOTAL LOADING PER ARM					Bolt Hole Circle (in.)	BASIC CATALOG NUMBER	Comment
			Shaft Top (in.)	Shaft Base (in.)		Total Weight (lbs.)	80 MPH EPA* (sq. ft.)	90 MPH EPA* (sq. ft.)	100 MPH EPA* (sq. ft.)	120 MPH EPA* (sq. ft.)			
Anchor Base pole with ONE 6-foot Mast Arm													
16	15	44	4.1	6.1	18	75	3.2*	3.2*	3.2*	2.5	8.5	A015-10	Arm: OPAR-6x4
18	17	51	4.1	6.3	18	75	3.2*	3.2*	3.2*	1.8	9.5	A017-10	Arm: OPAR-6x4
20	19	54	4.1	6.6	18	75	3.2*	3.2*	2.9	1.3	9.5	A019-10	Arm: OPAR-6x4
25	24	62	4.1	6.8	18	75	3.2*	2.0	1.1	--	9.5	A024-10	Arm: OPAR-6x4
25	24	68	4.4	7.1	18	75	3.2*	2.2	1.3	--	11.5	AG24-10	Arm: OPAR-6
25	24	81	4.6	7.3	18	75	3.2*	3.2*	3.2*	1.7	11.5	AH25-16	Arm: OPAR-6
30	29	116	4.7	8.4	18	75	3.2*	3.2*	3.2*	3.2*	11.5	AS30-16	Arm: OPAR-6
35	34	129	4.7	8.4	18	75	3.2*	3.2*	2.3	0.7	11.5	AS35-16	Arm: OPAR-6
40	39	179	6.2	11.5	18	75	3.2*	3.2*	1.8	--	15.5	AA40-16	Arm: OPAR-6x6
40	39	239	6.4	11.6	18	75	3.2*	3.2*	3.2*	1.6	15.5	AB40-16	Arm: OPAR-6x6
45	44	223	6.2	11.7	18	75	3.2*	1.9	--	--	15.5	AA45-16	Arm: OPAR-6x6
45	44	272	6.4	11.8	18	75	3.2*	3.2*	2.3	--	15.5	AB45-16	Arm: OPAR-6x6
45	44	312	6.6	11.9	18	75	3.2*	1.9	3.2*	2.5	15.5	AC45-16	Arm: OPAR-6x6
Anchor Base pole with TWO 6-foot Mast Arms @180°													
25	24	91	4.6	7.3	18	75	2.5	1.5	0.8	--	11.5	AH25-26	Arms: 2@ OPAR-6
25	24	128	6.2	9.4	18	75	3.2*	3.2*	3.2*	1.4	14	AA25-26	Arms: 2@ OPAR-6x6
30	29	126	4.7	8.4	18	75	3.2*	2.9	1.9	0.8	11.5	AS30-26	Arms: 2@ OPAR-6
30	29	160	4.9	8.5	18	75	3.2*	3.2*	3.2*	1.8	11.5	AH30-26	Arms: 2@ OPAR-6
35	34	139	4.7	8.4	18	75	1.6	0.8	--	--	11.5	AS35-26	Arms: 2@ OPAR-6
35	34	181	4.9	8.5	18	75	3.2*	2.2	1.3	--	11.5	AH35-26	Arms: 2@ OPAR-6
35	34	221	6.4	10.9	18	75	3.2*	3.2*	2.6	0.6	15	AB35-26	Arms: 2@ OPAR-6x6
35	34	253	6.6	11.0	18	75	3.2*	3.2*	3.2*	2.2	15	AC35-26	Arms: 2@ OPAR-6x6
40	39	250	6.4	11.6	18	75	3.2*	3.1	1.7	--	15.5	AB40-26	Arms: 2@ OPAR-6x6
40	39	285	6.6	11.7	18	75	3.2*	3.2*	3.2*	1.4	15.5	AC40-26	Arms: 2@ OPAR-6x6
45	44	282	6.4	11.8	18	75	3.2*	1.9	0.7	--	15.5	AB45-26	Arms: 2@ OPAR-6x6
45	44	322	6.6	11.9	18	75	3.2*	3.2*	2.6	0.4	15.5	AC45-26	Arms: 2@ OPAR-6x6
45	44	381	6.9	12.0	18	75	3.2*	3.2*	3.2*	1.6	15.5	AD45-26	Arms: 2@ OPAR-6x6
Anchor Base pole with FOUR 6-foot Mast Arms @90°													
25	24	111	4.6	7.3	18	75	1.7	1.0	0.5	--	11.5	AH25-46	Arms: 4@ OPAR-6
25	24	148	6.2	9.4	18	75	3.2*	3.0	2.1	1.1	14	AA25-46	Arms: 4@ OPAR-6x6
25	24	186	6.4	9.5	18	75	3.2*	3.2*	3.2*	2.5	14	AB25-46	Arms: 4@ OPAR-6x6
30	29	146	4.7	8.4	18	75	2.8	1.9	1.3	0.5	11.5	AS30-46	Arms: 4@ OPAR-6
30	29	180	4.9	8.5	18	75	3.2*	3.1	2.3	1.4	11.5	AH30-46	Arms: 4@ OPAR-6
30	29	213	6.4	10.2	18	75	1.1	3.2*	3.1	1.7	14.5	AB30-46	Arms: 4@ OPAR-6x6
35	34	159	4.7	8.4	18	75	2.3	0.5	--	--	11.5	AS35-46	Arms: 4@ OPAR-6
35	34	201	4.9	8.5	18	75	3.2*	1.5	0.9	--	11.5	AH35-46	Arms: 4@ OPAR-6
35	34	273	6.6	11.0	18	75	3.2*	3.2*	3.2*	1.7	15	AC35-46	Arms: 4@ OPAR-6x6
40	39	270	6.4	11.6	18	75	3.2*	2.1	1.1	--	15.5	AB40-46	Arms: 4@ OPAR-6x6
40	39	305	6.6	11.7	18	75	3.2*	3.2*	2.6	1.1	15.5	AC40-46	Arms: 4@ OPAR-6x6
40	39	363	6.9	11.9	18	75	3.2*	3.2*	3.2*	2.2	15.5	AD40-46	Arms: 4@ OPAR-6x6
45	44	302	6.4	11.8	18	75	3.2*	3.2*	0.5	--	15.5	AB45-46	Arms: 4@ OPAR-6x6
45	44	342	6.6	11.9	18	75	3.2*	3.2*	1.7	--	15.5	AC45-46	Arms: 4@ OPAR-6x6
45	44	401	6.9	12.0	18	75	3.2*	3.2*	3.0	1.3	15.5	AD45-46	Arms: 4@ OPAR-6x6

■ See footnotes, next page

6' Mast Arm Round Tapered Composite Tuff-Poles®

BA, BB, BC, BH, B0, BS, and BX Series, Direct Burial Base

One, Two, or Four Shakespeare 6-foot Mast Arms

**COMPOSITE
TUFF-POLE**

Nominal Mounting Height (ft.)	Shaft Length (ft.)	Pole Weight (lbs.)	POLE DIAMETER		Standard Handhole Location from Base (in.)	SUGGESTED MAXIMUM TOTAL LOADING PER ARM					Suggested Burial Depth (ft.)	BASIC CATALOG NUMBER	Comment
			Shaft Top (in.)	Shaft Base (in.)		Total Weight (lbs.)	80 MPH EPA* (sq. ft.)	90 MPH EPA* (sq. ft.)	100 MPH EPA* (sq. ft.)	120 MPH EPA* (sq. ft.)			
Direct Burial Base pole with ONE 6-foot Mast Arm													
16	19	47	4.1	6.5	66	75	3.2*	3.2*	3.2*	2.5	4	B019-10	Arm: OPAR-6x4
18	21	50	4.1	6.7	66	75	3.2*	3.2*	3.2*	1.8	4	B021-10	Arm: OPAR-6x4
20	23	57	4.1	6.8	66	75	3.2*	3.2*	2.9	1.3	4	B023-10	Arm: OPAR-6x4
20	23	68	4.6	7.3	66	75	3.2*	3.2*	3.2*	3.2	4	BH24-16	Arm: OPAR-6
25	29	81	4.5	8.2	78	75	3.2*	3.2*	2.4	0.9	5	BS30-16	Arm: OPAR-6
25	29	108	4.7	8.4	78	75	3.2*	3.2*	3.2*	3.2*	5	BH30-16	Arm: OPAR-6
30	34	92	4.5	8.3	78	75	2.6	1.9	0.7	--	5	BS35-16	Arm: OPAR-6
30	34	126	4.7	8.4	78	75	3.2*	3.2*	3.2*	3.2*	5	BH35-16	Arm: OPAR-6
35	40	159	6.2	11.6	90	75	3.2*	3.2*	3.2*	0.5	6	BA41-16	Arm: OPAR-6x6
40	46	182	6.2	11.7	102	75	3.2*	3.2*	1.8	--	7	BA47-16	Arm: OPAR-6x6
40	46	253	6.4	11.8	102	75	3.2*	3.2*	3.2*	1.6	7	BB47-16	Arm: OPAR-6x6
Direct Burial Base pole with TWO 6-foot Mast Arms @180°													
20	23	67	4.1	6.8	66	75	2.2	1.2	0.6	--	4	B023-20	Arms: 2@ OPAR-6x4
25	29	91	4.5	8.2	78	75	1.6	0.8	--	--	5	BS30-26	Arms: 2@ OPAR-6
25	29	118	4.7	8.4	78	75	3.2*	3.2*	3.2*	1.5	5	BH30-26	Arms: 2@ OPAR-6
30	34	136	4.5	8.4	78	75	3.2*	2.9	1.9	0.8	5	BH35-26	Arms: 2@ OPAR-6
30	34	173	4.9	8.5	78	75	3.2*	3.2*	3.2*	1.8	5	BX35-26	Arms: 2@ OPAR-6
35	40	169	6.2	11.6	90	75	2.8	1.7	1.7	--	6	BA41-26	Arms: 2@ OPAR-6x6
35	40	231	6.4	11.7	90	75	3.2*	3.2*	2.6	0.6	6	BB41-26	Arms: 2@ OPAR-6x6
35	40	268	6.6	11.8	90	75	3.2*	3.2*	3.2*	2.2	6	BC41-26	Arms: 2@ OPAR-6x6
40	46	192	6.4	11.7	102	75	2.0	1.0	--	--	7	BB47-26	Arms: 2@ OPAR-6x6
40	46	263	6.6	11.9	102	75	3.2*	3.1	1.7	--	7	BC47-26	Arms: 2@ OPAR-6x6
40	46	305	6.9	12.0	102	75	3.2*	3.2*	3.2*	1.4	7	BD47-26	Arms: 2@ OPAR-6x6
Direct Burial Base pole with FOUR 6-foot Mast Arms @90°													
25	29	111	4.5	8.2	78	75	1.1	0.5	--	--	5	BS30-46	Arms: 4@ OPAR-6
25	29	138	4.7	8.4	78	75	3.2*	3.1	2.2	1.2	5	BH30-46	Arms: 4@ OPAR-6
25	29	172	4.9	8.5	78	75	3.2*	3.2*	3.2*	2.2	5	BX30-46	Arms: 4@ OPAR-6
30	34	166	6.2	10.8	78	75	3.2*	2.3	1.5	0.4	5	BA35-46	Arms: 4@ OPAR-6x6
30	34	219	6.4	10.9	78	75	3.2*	3.2*	3.1	1.7	5	BB35-46	Arms: 4@ OPAR-6x6
35	40	189	6.2	11.6	90	75	1.9	1.1	0.5	--	6	BA41-46	Arms: 4@ OPAR-6x6
35	40	251	6.4	11.7	90	75	3.2*	2.7	1.7	0.4	6	BB41-46	Arms: 4@ OPAR-6x6
35	40	288	6.6	11.8	90	75	3.2*	3.2*	3.2*	1.8	6	BC41-46	Arms: 4@ OPAR-6x6
40	46	283	6.4	11.7	102	75	3.2*	2.1	1.1	--	7	BB47-46	Arms: 4@ OPAR-6x6
40	46	325	6.6	11.9	102	75	3.2*	3.2*	2.6	1.1	7	BC47-46	Arms: 4@ OPAR-6x6
40	46	387	6.9	12.0	102	75	3.2*	3.2*	3.2*	2.2	7	BD47-46	Arms: 4@ OPAR-6x6

■ Standard handhole: 2½" x 5" oval. Handhole covers are polyurethane coated to match pole color. ■ All poles are individually wrapped for shipment. ■ Poles on this page are predrilled for Shakespeare 6' Mast Arms. ■ Aluminum cap and wiring access hole standard. *Poles are not rated above 3.2 EPA because the mast arms are not rated for luminaires greater than 3.2 EPA each. EPA and weight specifications include the arm(s). All EPA recommendations are based on poles with handholes, and include a 30% gust factor.

8' Mast Arm Round Tapered Composite Tuff-Poles®

AA, AB, AC, AD, AH, AO, and AS Series, Anchor Base

One or Two Shakespeare 8-foot Mast Arms



Nominal Mounting Height (ft.)	Shaft Length (ft.)	Pole Weight (lbs.)	POLE DIAMETER		Standard Handhole Location from Base (in.)	SUGGESTED MAXIMUM TOTAL LOADING PER ARM					Bolt Hole Circle (in.)	BASIC CATALOG NUMBER	Comment	
			Shaft Top (in.)	Shaft Base (in.)		Total Weight (lbs.)	80 MPH EPA* (sq. ft.)	90 MPH EPA* (sq. ft.)	100 MPH EPA* (sq. ft.)	120 MPH EPA* (sq. ft.)				
Anchor Base pole with ONE 8-foot Mast Arm														
18	16	50	4.1	6.2	18	75	3.2*	3.2*	3.1	1.3	8.5	A016-10	Arm: OPAR-8x4	
20	18	54	4.1	6.5	18	75	3.2*	3.2*	2.4	0.8	9.5	A018-10	Arm: OPAR-8x4	
25	23	67	4.1	6.8	18	75	3.2*	1.7	0.7	--	9.5	A023-10	Arm: OPAR-8x4	
25	23	88	4.6	7.3	18	75	3.2*	3.2*	2.9	1.1	11.5	AH25-18	Arm: OPAR-8	
30	28	122	4.7	8.4	18	75	3.2*	3.2*	3.2*	2.7	11.5	AS30-18	Arm: OPAR-8	
35	33	136	4.7	8.4	18	75	3.2*	3.2*	2.5	0.8	11.5	AS35-18	Arm: OPAR-8	
35	33	171	4.9	8.5	18	75	3.2*	3.2*	3.2*	2.3	11.5	AH35-18	Arm: OPAR-8	
40	38	179	6.2	11.3	18	75	3.2*	3.1	1.2	--	15.5	AA40-18	Arm: OPAR-8x6	
40	38	238	6.4	11.4	18	75	3.2*	3.2*	3.2*	1.0	15.5	AB40-18	Arm: OPAR-8x6	
45	43	271	6.4	11.8	18	75	3.2*	3.2*	2.7	--	15.5	AB45-18	Arm: OPAR-8x6	
45	43	310	6.6	11.9	18	75	3.2*	3.2*	3.2*	2.1	15.5	AC45-18	Arm: OPAR-8x6	
Anchor Base pole with TWO 8-foot Mast Arms @180°														
25	23	102	4.6	7.3	18	75	1.8	0.9	--	--	11.5	AH25-28	Arms: 2@ OPAR-8	
25	23	135	6.2	9.2	18	75	3.2*	3.2*	2.6	0.7	14	AA25-28	Arms: 2@ OPAR-8x6	
25	23	168	6.4	9.4	18	75	3.2*	3.2*	3.2*	2.5	14	AB25-28	Arms: 2@ OPAR-8x6	
30	28	135	4.7	8.4	18	75	3.2*	2.2	1.3	--	11.5	AS30-28	Arms: 2@ OPAR-8	
30	28	164	4.9	8.5	18	75	3.2*	3.2*	2.8	1.1	11.5	AH30-28	Arms: 2@ OPAR-8	
30	28	193	6.4	10.1	18	75	3.2*	3.2*	3.2*	1.5	14.5	AB30-28	Arms: 2@ OPAR-8x6	
35	33	150	4.7	8.4	18	75	1.5	0.6	--	--	11.5	AS35-28	Arms: 2@ OPAR-8	
35	33	185	4.9	8.5	18	75	3.2*	2.0	1.1	--	11.5	AH35-28	Arms: 2@ OPAR-8	
35	33	225	6.4	10.7	18	75	3.2*	3.2*	1.9	--	15	AB35-28	Arms: 2@ OPAR-8x6	
35	33	253	6.6	10.9	18	75	3.2*	3.2*	3.2*	1.6	15	AC35-28	Arms: 2@ OPAR-8x6	
40	38	252	6.4	11.4	18	75	3.2*	2.4	1.0	--	15.5	AB40-28	Arms: 2@ OPAR-8x6	
40	38	286	6.6	11.5	18	75	3.2*	3.2*	3.2*	0.7	15.5	AC40-28	Arms: 2@ OPAR-8x6	
45	43	285	6.4	11.8	18	75	2.8	1.3	--	--	15.5	AB45-28	Arms: 2@ OPAR-8x6	
45	43	324	6.6	11.9	18	75	3.2*	3.2*	2.0	--	15.5	AC45-28	Arms: 2@ OPAR-8x6	
45	43	382	6.9	12.0	18	75	3.2*	3.2*	3.2*	1.0	15.5	AD45-28	Arms: 2@ OPAR-8x6	

For Anchor Base poles with FOUR 8-foot Mast Arms see next page

■ Standard handhole: 2½" x 5" oval. Handhole covers are polyurethane coated to match pole color. ■ All poles are individually wrapped for shipment. ■ Poles on this page are predrilled for Shakespeare 8' Mast Arms. ■ Aluminum cap standard.

*Poles are not rated above 3.2 EPA because the mast arms are not rated for luminaires greater than 3.2 EPA each. EPA and weight specifications include the arm(s). All EPA recommendations are based on poles with handholes, and include a 30% gust factor.

8' Mast Arm Round Tapered Composite Tuff-Poles®

AA, AB, AC, AD, AH, AO, and AS Series, Anchor Base

Four Shakespeare 8-foot Mast Arms

**COMPOSITE
TUFF-POLE**

Nominal Mounting Height (ft.)	Shaft Length (ft.)	Pole Weight (lbs.)	POLE DIAMETER		Standard Handhole Location from Base (in.)	SUGGESTED MAXIMUM TOTAL LOADING PER ARM					Bolt Hole Circle (in.)	BASIC CATALOG NUMBER	Comment
			Shaft Top (in.)	Shaft Base (in.)		Total Weight (lbs.)	80 MPH EPA* (sq. ft.)	90 MPH EPA* (sq. ft.)	100 MPH EPA* (sq. ft.)	120 MPH EPA* (sq. ft.)			
Anchor Base pole with FOUR 8-foot Mast Arms @90°													
25	23	130	4.6	7.3	18	75	1.2	0.6	--	--	11.5	AH25-48	Arms: 4@ OPAR-8
25	23	163	6.2	9.2	18	75	3.2*	2.5	1.7	0.5	14	AA25-48	Arms: 4@ OPAR-8x6
25	23	196	6.4	9.4	18	75	3.2*	3.2*	3.2*	2.0	14	AB25-48	Arms: 4@ OPAR-8x6
30	28	163	4.7	8.4	18	75	2.4	1.5	0.9	--	11.5	AS30-48	Arms: 4@ OPAR-8
30	28	192	4.9	8.5	18	75	3.2*	2.7	1.9	0.9	11.5	AH30-48	Arms: 4@ OPAR-8
30	28	245	6.6	10.2	18	75	3.2*	3.2*	3.2*	2.8	14.5	AC30-48	Arms: 4@ OPAR-8x6
35	33	213	4.9	8.5	18	75	2.3	1.3	0.7	--	11.5	AH35-48	Arms: 4@ OPAR-8
35	33	253	6.4	10.7	18	75	3.2*	2.3	1.3	--	15	AB35-48	Arms: 4@ OPAR-8x6
35	33	281	6.6	10.9	18	75	3.2*	3.2*	2.9	1.2	15	AC35-48	Arms: 4@ OPAR-8x6
35	33	325	6.9	11.0	18	75	3.2*	3.2*	3.2*	2.5	15	AD35-48	Arms: 4@ OPAR-8x6
40	38	280	6.4	11.4	18	75	2.8	1.6	0.7	--	15.5	AB40-48	Arms: 4@ OPAR-8x6
40	38	314	6.6	11.5	18	75	3.2*	3.2*	2.1	0.5	15.5	AC40-48	Arms: 4@ OPAR-8x6
40	38	363	6.9	11.6	18	75	3.2*	3.2*	3.2*	1.7	15.5	AD40-48	Arms: 4@ OPAR-8x6
45	45	313	6.4	11.8	18	75	1.9	0.9	--	--	15.5	AB45-48	Arms: 4@ OPAR-8x6
45	45	352	6.6	11.9	18	75	3.2*	2.5	1.3	--	15.5	AC45-48	Arms: 4@ OPAR-8x6
45	45	410	6.9	12.0	18	75	3.2*	3.2*	2.5	0.8	15.5	AD45-48	Arms: 4@ OPAR-8x6

■ Standard handhole: 2½" x 5" oval. Handhole covers are polyurethane coated to match pole color. ■ All poles are individually wrapped for shipment. ■ Poles on this page are predrilled for Shakespeare 8' Mast Arms. ■ Aluminum cap standard.

*Poles are not rated above 3.2 EPA because the mast arms are not rated for luminaires greater than 3.2 EPA each. EPA and weight specifications include the arm(s). All EPA recommendations are based on poles with handholes, and include a 30% gust factor.

8' Mast Arm Round Tapered Composite Tuff-Poles®

BA, BB, BC, BD, BH, B0, BS, and BX Series, Direct Burial Base

One, Two, or Four Shakespeare 8-foot Mast Arms



Nominal Mounting Height (ft.)	Shaft Length (ft.)	Pole Weight (lbs.)	POLE DIAMETER		Standard Handhole Location from Base (in.)	SUGGESTED MAXIMUM TOTAL LOADING PER ARM					Suggested Burial Depth (ft.)	BASIC CATALOG NUMBER	Comment
			Shaft Top (in.)	Shaft Base (in.)		Total Weight (lbs.)	80 MPH EPA* (sq. ft.)	90 MPH EPA* (sq. ft.)	100 MPH EPA* (sq. ft.)	120 MPH EPA* (sq. ft.)			
Direct Burial Base pole with ONE 8-foot Mast Arm													
18	20	52	4.1	6.7	66	75	3.2*	3.2*	3.1	1.3	4	B020-10	Arm: OPAR-8x4
20	22	57	4.1	6.7	66	75	3.2*	3.2*	2.4	0.7	4	B022-10	Arm: OPAR-8x4
20	22	70	4.6	7.3	66	75	3.2*	3.2*	3.2*	3.0	4	BH24-18	Arm: OPAR-8
25	28	81	4.5	8.2	78	75	3.2*	3.2*	1.8	--	5	BS30-18	Arm: OPAR-8
25	28	108	4.7	8.4	78	75	3.2*	3.2*	3.2*	3.2*	5	BH30-18	Arm: OPAR-8
30	33	92	4.5	8.3	78	75	2.1	0.9	--	--	5	BS35-18	Arm: OPAR-8
30	33	125	4.7	8.4	78	75	3.2*	3.2*	3.2*	2.7	5	BH35-18	Arm: OPAR-8
35	39	160	6.2	11.5	90	75	3.2*	3.2*	2.7	--	6	BA41-18	Arm: OPAR-8x6
35	39	222	6.4	11.6	90	75	3.2*	3.2*	3.2*	2.4	6	BB41-18	Arm: OPAR-8x6
40	45	183	6.2	11.7	102	75	3.2*	3.2*	1.2	--	7	BA47-18	Arm: OPAR-8x6
40	45	253	6.4	11.8	102	75	3.2*	3.2*	3.2*	1.0	7	BB47-18	Arm: OPAR-8x6
Direct Burial Base pole with TWO 8-foot Mast Arms @180°													
25	28	122	4.7	8.4	78	75	3.2*	3.2*	2.7	0.8	5	BH30-28	Arms: 2@ OPAR-8
25	28	154	4.9	8.5	78	75	3.2*	3.2*	3.2*	2.0	5	BX30-28	Arms: 2@ OPAR-8
30	33	139	4.7	8.4	78	75	3.2*	2.2	1.3	--	5	BH35-28	Arms: 2@ OPAR-8
30	33	176	4.9	8.5	78	75	3.2*	3.2*	2.8	1.1	5	BX35-28	Arms: 2@ OPAR-8
30	33	203	6.4	10.7	78	75	3.2*	3.2*	3.2*	1.5	5	BB35-28	Arms: 2@ OPAR-8x6
35	39	236	6.4	11.6	90	75	3.2*	3.2*	1.9	--	6	BB41-28	Arms: 2@ OPAR-8x6
35	39	271	6.6	11.7	90	75	3.2*	3.2*	3.2*	1.5	6	BC41-28	Arms: 2@ OPAR-8x6
40	45	267	6.4	11.8	102	75	3.2*	2.4	1.0	--	7	BB47-28	Arms: 2@ OPAR-8x6
40	45	310	6.6	11.9	102	75	3.2*	3.2*	3.2*	0.7	7	BC47-28	Arms: 2@ OPAR-8x6
Direct Burial Base pole with FOUR 8-foot Mast Arms @90°													
25	28	150	4.7	8.4	78	75	3.2*	2.6	1.8	1.8	5	BH30-48	Arms: 4@ OPAR-8
25	28	182	4.9	8.5	78	75	3.2*	3.2*	3.0	3.0	5	BX30-48	Arms: 4@ OPAR-8
30	33	167	4.7	8.4	78	75	2.4	1.5	0.9	0.9	5	BH35-48	Arms: 4@ OPAR-8
30	33	204	4.9	8.5	78	75	3.2*	2.7	1.9	1.9	5	BX35-48	Arms: 4@ OPAR-8
30	33	262	6.6	10.9	78	75	3.2*	3.2*	3.2*	3.2*	5	BC35-48	Arms: 4@ OPAR-8x6
35	39	264	6.4	11.6	90	75	3.2*	2.3	1.3	1.3	6	BB41-48	Arms: 4@ OPAR-8x6
35	39	299	6.6	11.7	90	75	3.2*	3.2*	2.9	2.9	6	BC41-48	Arms: 4@ OPAR-8x6
35	39	349	6.9	11.8	90	75	3.2*	3.2*	3.2*	3.2*	6	BD41-48	Arms: 4@ OPAR-8x6
40	45	295	6.4	11.8	102	75	2.8	1.6	0.7	0.7	7	BB47-48	Arms: 4@ OPAR-8x6
40	45	338	6.6	11.9	102	75	3.2*	3.2*	2.1	2.1	7	BC47-48	Arms: 4@ OPAR-8x6
40	45	395	6.9	12.0	102	75	3.2*	3.2*	3.2*	3.2*	7	BD47-48	Arms: 4@ OPAR-8x6

■ Standard handhole: 2½" x 5" oval. Handhole covers are polyurethane coated to match pole color. ■ All poles are individually wrapped for shipment. ■ Poles on this page are predrilled for Shakespeare 8' Mast Arms. ■ Aluminum cap and wiring access hole standard.

*Poles are not rated above 3.2 EPA because the mast arms are not rated for luminaires greater than 3.2 EPA each. EPA and weight specifications include the arm(s). All EPA recommendations are based on poles with handholes, and include a 30% gust factor.

About EPA Ratings for Poles with Arms

- Poles are not rated above 3.2 EPA because the mast arms are not rated for luminaires greater than 3.2 EPA each.
- EPA and weight specifications are per arm, and are calculated to *include* the arm(s)
- Shakespeare Composite Structures calculates all EPA recommendations, *including 120 mph*, to include a 30% gust factor.
- All EPA ratings are based on poles *with* handholes.



Arm Dimensions

Arm Length	SPAN	RISE
4'	45"	15"
6'	68"	24"
8'	90"	33"
10'	120"	39"
12'	138"	45"
15'	174"	45"

10' Mast Arm Round Tapered Composite Tuff-Poles®

AA, AB, AC, AH, and AS Series, Anchor Base

One, Two or Four Shakespeare 10-foot Mast Arms



Nominal Mounting Height (ft.)	Shaft Length (ft.)	Pole Weight (lbs.)	POLE DIAMETER		Standard Handhole Location from Base (in.)	SUGGESTED MAXIMUM TOTAL LOADING PER ARM				Bolt Hole Circle (in.)	BASIC CATALOG NUMBER	Comment	
			Shaft Top (in.)	Shaft Base (in.)		Total Weight (lbs.)	80 MPH EPA* (sq. ft.)	90 MPH EPA* (sq. ft.)	100 MPH EPA* (sq. ft.)				120 MPH EPA* (sq. ft.)
Anchor Base pole with ONE 10-foot Mast Arm													
20	17.5	69	4.6	7.3	18	75	3.2*	3.2*	3.2*	2.3	9.5	A020-10	Arm: OPAR-10x4
25	22.5	85	4.6	7.3	18	75	3.2*	3.2*	2.2	0.4	11.5	AH25-11	Arm: OPAR-10
25	22.5	121	6.2	9.1	18	75	3.2*	3.2*	3.2*	3.1	14	AA25-11	Arm: OPAR-10x6
30	27.5	118	4.7	8.3	18	75	3.2*	3.2*	3.2*	2.0	11.5	AS30-11	Arm: OPAR-10
35	32.5	136	4.7	8.4	18	75	3.2*	3.2*	1.8	--	11.5	AS35-11	Arm: OPAR-10
35	32.5	189	4.9	8.5	18	75	3.2*	3.2*	3.2*	1.6	11.5	AH35-11	Arm: OPAR-10
40	37.5	182	6.2	11.2	18	75	3.2*	2.4	0.5	--	15.5	AA40-11	Arm: OPAR-10x6
40	37.5	215	6.4	11.3	18	75	3.2*	3.2*	3.2*	--	15.5	AB40-11	Arm: OPAR-10x6
45	42.5	206	6.2	11.7	18	75	3.2*	0.7	--	--	15.5	AA45-11	Arm: OPAR-10x6
45	42.5	244	6.4	11.8	18	75	3.2*	3.2*	2.0	--	15.5	AB45-11	Arm: OPAR-10x6
45	42.5	311	6.6	11.9	18	75	3.2*	3.2*	3.2*	1.4	15.5	AC45-11	Arm: OPAR-10x6
Anchor Base pole with TWO 10-foot Mast Arms @180°													
25	22.5	138	6.2	9.1	18	75	3.2*	2.9	1.8	--	14	AA25-21	Arms: 2@ OPAR-10x6
25	22.5	159	6.4	9.3	18	75	3.2*	3.2*	3.2*	1.7	14	AB25-21	Arms: 2@ OPAR-10x6
30	27.5	135	4.7	8.3	18	75	2.8	1.5	0.5	--	11.5	AS30-21	Arms: 2@ OPAR-10
30	27.5	168	4.9	8.4	18	75	3.2*	3.2*	2.0	0.4	11.5	AH30-21	Arms: 2@ OPAR-10
30	27.5	183	6.4	10.0	18	75	3.2*	3.2*	3.0	0.7	14.5	AB30-21	Arms: 2@ OPAR-10x6
35	32.5	206	4.9	8.5	18	75	2.6	1.3	0.3	--	11.5	AH35-21	Arms: 2@ OPAR-10
35	32.5	229	6.4	10.6	18	75	3.2*	3.0	1.5	--	15	AB35-21	Arms: 2@ OPAR-10x6
35	32.5	259	6.6	10.8	18	75	3.2*	3.2*	3.2*	1.2	15	AC35-21	Arms: 2@ OPAR-10x6
40	37.5	232	6.4	11.3	18	75	3.2*	1.6	--	--	15.5	AB40-21	Arms: 2@ OPAR-10x6
40	37.5	291	6.6	11.4	18	75	3.2*	3.2*	2.4	--	15.5	AC40-21	Arms: 2@ OPAR-10x6
40	37.5	343	6.9	11.6	18	75	3.2*	3.2*	3.2*	1.3	15.5	AD40-21	Arms: 2@ OPAR-10x6
45	42.5	328	6.6	11.9	18	75	3.2*	3.0	1.2	--	15.5	AC45-21	Arms: 2@ OPAR-10x6
45	42.5	386	6.9	12.0	18	75	3.2*	3.2*	3.0	--	15.5	AD45-21	Arms: 2@ OPAR-10x6
Anchor Base pole with FOUR 10-foot Mast Arms @90°													
25	22.5	172	6.2	9.1	18	75	3.1	2.0	1.2	--	14	AA25-41	Arms: 4@ OPAR-10x6
25	22.5	193	6.4	9.3	18	75	3.2*	3.2*	2.9	1.4	14	AB25-41	Arms: 4@ OPAR-10x6
25	22.5	227	6.6	9.4	18	75	3.2*	3.2*	3.2*	3.0	14	AC25-41	Arms: 4@ OPAR-10x6
30	27.5	202	4.9	8.4	18	75	3.2*	2.2	1.3	0.3	11.5	AH30-41	Arms: 4@ OPAR-10
30	27.5	259	6.6	10.1	18	75	3.2*	3.2*	3.2*	2.1	14.5	AC30-41	Arms: 4@ OPAR-10x6
35	32.5	263	6.4	10.6	18	75	3.2*	2.0	1.0	--	15	AB35-41	Arms: 4@ OPAR-10x6
35	32.5	293	6.6	10.8	18	75	3.2*	3.2*	2.6	0.9	15	AC35-41	Arms: 4@ OPAR-10x6
35	32.5	338	6.9	10.9	18	75	3.2*	3.2*	3.2*	2.1	15	AD35-41	Arms: 4@ OPAR-10x6
40	37.5	266	6.4	11.3	18	75	3.2*	1.3	--	--	15.5	AB40-41	Arms: 4@ OPAR-10x6
40	37.5	325	6.6	11.4	18	75	3.2*	2.9	1.6	--	15.5	AC40-41	Arms: 4@ OPAR-10x6
40	37.5	377	6.9	11.6	18	75	3.2*	3.2*	2.9	1.0	15.5	AD40-41	Arms: 4@ OPAR-10x6
45	42.5	362	6.6	11.9	18	75	3.2*	2.0	0.8	--	15.5	AC45-41	Arms: 4@ OPAR-10x6
45	42.5	420	6.9	12.0	18	75	3.2*	3.2*	2.1	--	15.5	AD45-41	Arms: 4@ OPAR-10x6

■ Standard handhole: 2½" x 5" oval. Handhole covers are polyurethane coated to match pole color. ■ All poles are individually wrapped for shipment. ■ Poles on this page are predrilled for Shakespeare 10' Mast Arms. ■ Aluminum cap standard.

*Poles are not rated above 3.2 EPA because the mast arms are not rated for luminaires greater than 3.2 EPA each. EPA and weight specifications include the arm(s). All EPA recommendations are based on poles with handholes, and include a 30% gust factor.

10' Mast Arm Round Tapered Composite Tuff-Poles®

BA, BB, BC, BH, BS, and BX Series, Direct Burial Base

One, Two or Four Shakespeare 10-foot Mast Arms

**COMPOSITE
TUFF-POLE**

Nominal Mounting Height (ft.)	Shaft Length (ft.)	Pole Weight (lbs.)	POLE DIAMETER		Standard Handhole Location from Base (in.)	SUGGESTED MAXIMUM TOTAL LOADING PER ARM				Suggested Burial Depth (ft.)	BASIC CATALOG NUMBER	Comment	
			Shaft Top (in.)	Shaft Base (in.)		Total Weight (lbs.)	80 MPH EPA* (sq. ft.)	90 MPH EPA* (sq. ft.)	100 MPH EPA* (sq. ft.)				120 MPH EPA* (sq. ft.)
Direct Burial Base pole with ONE 10-foot Mast Arm													
20	21.5	82	4.6	7.3	66	75	3.2*	3.2*	3.2*	2.3	4	BH24-11	Arm: OPAR-10
25	27.5	84	4.5	8.2	78	75	3.2*	2.2	1.1	--	5	BS30-11	Arm: OPAR-10
25	27.5	110	4.7	8.3	78	75	3.2*	3.2*	3.2*	3.2*	5	BH30-11	Arm: OPAR-10
30	32.5	128	4.7	8.4	78	75	3.2*	3.2*	3.2*	2.0	5	BH35-11	Arm: OPAR-10
35	38.5	161	6.2	11.4	90	75	3.2*	3.2*	2.7	--	6	BA41-11	Arm: OPAR-10x6
35	38.5	196	6.4	11.5	90	75	3.2*	3.2*	3.2*	2.5	6	BB41-11	Arm: OPAR-10x6
40	44.5	184	6.2	11.7	102	75	3.2*	2.4	0.5	--	7	BA47-11	Arm: OPAR-10x6
40	44.5	254	6.4	11.8	102	75	3.2*	3.2*	3.2*	--	7	BB47-11	Arm: OPAR-10x6
Direct Burial Base pole with TWO 10-foot Mast Arms @180°													
25	27.5	127	4.7	8.3	78	75	3.2*	3.2*	1.9	--	5	BH30-21	Arms: 2@ OPAR-10
25	27.5	160	4.9	8.4	78	75	3.2*	3.2*	3.2*	1.2	5	BX30-21	Arms: 2@ OPAR-10
30	32.5	145	4.7	8.4	78	75	2.8	1.5	0.5	--	5	BH35-21	Arms: 2@ OPAR-10
30	32.5	181	4.9	8.5	78	75	3.2*	3.2*	2.0	0.4	5	BX35-21	Arms: 2@ OPAR-10
30	32.5	206	6.4	10.6	78	75	3.2*	3.2*	3.0	0.7	5	BB35-21	Arms: 2@ OPAR-10x6
35	38.5	239	6.4	11.5	90	75	2.6	3.0	1.5	--	6	BB41-21	Arms: 2@ OPAR-10x6
35	38.5	274	6.6	11.6	90	75	3.2*	3.2*	3.2*	1.2	6	BC41-21	Arms: 2@ OPAR-10x6
40	44.5	271	6.4	11.8	102	75	3.2*	1.6	--	--	7	BB47-21	Arms: 2@ OPAR-10x6
40	44.5	311	6.6	11.9	102	75	3.2*	3.2*	2.4	--	7	BC47-21	Arms: 2@ OPAR-10x6
40	44.5	372	6.9	12.0	102	75	3.2*	3.2*	3.2*	1.3	7	BD47-21	Arms: 2@ OPAR-10x6
Direct Burial Base pole with FOUR 10-foot Mast Arms @90°													
25	27.5	161	4.7	8.3	78	75	3.2*	2.1	1.3	--	5	BH30-41	Arms: 4@ OPAR-10
25	27.5	194	4.9	8.4	78	75	3.2*	3.2*	2.5	0.9	5	BX30-41	Arms: 4@ OPAR-10
25	27.5	239	6.6	10.1	78	75	3.2*	3.2*	3.2*	3.0	5	BC30-41	Arms: 4@ OPAR-10x6
30	32.5	215	4.9	8.5	78	75	3.2*	2.2	1.3	0.3	5	BX35-41	Arms: 4@ OPAR-10
30	32.5	240	6.4	10.6	78	75	3.2*	3.1	2.0	0.5	5	BB35-41	Arms: 4@ OPAR-10x6
30	32.5	270	6.6	10.8	78	75	3.2*	3.2*	3.2*	2.1	5	BC35-41	Arms: 4@ OPAR-10x6
35	38.5	273	6.4	11.5	90	75	3.2*	2.0	1.0	--	6	BB41-41	Arms: 4@ OPAR-10x6
35	38.5	308	6.6	11.6	90	75	3.2*	3.2*	2.6	0.9	6	BC41-41	Arms: 4@ OPAR-10x6
35	38.5	360	6.9	11.7	90	75	3.2*	3.2*	3.2*	2.2	6	BD41-41	Arms: 4@ OPAR-10x6
40	44.5	305	6.4	11.8	102	75	3.2*	1.3	--	--	7	BB47-41	Arms: 4@ OPAR-10x6
40	44.5	345	6.6	11.9	102	75	3.2*	2.9	1.6	--	7	BC47-41	Arms: 4@ OPAR-10x6
40	44.5	406	6.9	12.0	102	75	3.2*	3.2*	2.9	1.0	7	BD47-41	Arms: 4@ OPAR-10x6

■ Standard handhole: 2½" x 5" oval. Handhole covers are polyurethane coated to match pole color. ■ All poles are individually wrapped for shipment. ■ Poles on this page are predrilled for Shakespeare 10' Mast Arms. ■ Aluminum cap and wiring access hole standard. *Poles are not rated above 3.2 EPA because the mast arms are not rated for luminaires greater than 3.2 EPA each. EPA and weight specifications include the arm(s). All EPA recommendations are based on poles with handholes, and include a 30% gust factor.

12' Mast Arm Round Tapered Composite Tuff-Poles®

AA, AB, AC, AD, AH, and AS Series, Anchor Base

One or Two Shakespeare 12-foot Mast Arms



Nominal Mounting Height (ft.)	Shaft Length (ft.)	Pole Weight (lbs.)	POLE DIAMETER		Standard Handhole Location from Base (in.)	SUGGESTED MAXIMUM TOTAL LOADING PER ARM					Bolt Hole Circle (in.)	BASIC CATALOG NUMBER	Comment
			Shaft Top (in.)	Shaft Base (in.)		Total Weight (lbs.)	80 MPH EPA* (sq. ft.)	90 MPH EPA* (sq. ft.)	100 MPH EPA* (sq. ft.)	120 MPH EPA* (sq. ft.)			
Anchor Base pole with ONE 12-foot Mast Arm													
25	22	86	4.6	7.3	18	75	3.2*	3.1	1.7	--	11.5	AH25-12	Arm: OPAR-12
25	22	123	6.2	9.1	18	75	3.2*	3.2*	3.2*	2.5	14	AA25-12	Arm: OPAR-12x6
30	27	119	4.7	8.3	18	75	3.2*	3.2*	3.2*	1.4	11.5	AS30-12	Arm: OPAR-12
35	32	138	4.7	8.4	18	75	3.2*	2.7	1.3	--	11.5	AS35-12	Arm: OPAR-12
35	32	173	4.9	8.5	18	75	3.2*	3.2*	3.2*	1.1	11.5	AH35-12	Arm: OPAR-12
40	37	183	6.2	11.2	18	75	3.2*	1.9	--	--	15.5	AA40-12	Arm: OPAR-12x6
40	37	240	6.4	11.3	18	75	3.2*	3.2*	3.2*	--	15.5	AB40-12	Arm: OPAR-12x6
45	42	273	6.4	11.8	18	75	3.2*	3.2*	1.5	--	15.5	AB45-12	Arm: OPAR-12x6
45	42	312	6.4	11.9	18	75	3.2*	3.2*	3.2*	0.9	15.5	AC45-12	Arm: OPAR-12x6
Anchor Base pole with TWO 12-foot Mast Arms @180°													
25	22	143	6.2	9.1	18	75	3.2*	2.4	1.2	--	14	AA25-22	Arms: 2@ OPAR-12x6
25	22	177	6.4	9.2	18	75	3.2*	3.2*	3.2*	1.1	14	AB25-22	Arms: 2@ OPAR-12x6
30	27	173	4.9	8.4	18	75	3.2*	2.7	1.4	--	11.5	AH30-22	Arms: 2@ OPAR-12
30	27	202	6.4	9.9	18	75	3.2*	3.2*	2.4	0.7	14.5	AB30-22	Arms: 2@ OPAR-12x6
30	27	227	6.6	10.1	18	75	3.2*	3.2*	3.2*	2.0	14.5	AC30-22	Arms: 2@ OPAR-12x6
35	32	232	6.4	10.6	18	75	3.2*	2.3	0.9	--	15	AB35-22	Arms: 2@ OPAR-12x6
35	32	262	6.6	10.7	18	75	3.2*	3.2*	3.2*	0.6	15	AC35-22	Arms: 2@ OPAR-12x6
40	37	260	6.4	11.3	18	75	2.6	1.0	--	--	15.5	AB40-22	Arms: 2@ OPAR-12x6
40	37	295	6.6	11.4	18	75	3.2*	3.2*	1.8	--	15.5	AC40-22	Arms: 2@ OPAR-12x6
40	37	345	6.9	11.5	18	75	3.2*	3.2*	3.2*	0.7	15.5	AD40-22	Arms: 2@ OPAR-12x6
45	42	332	6.6	11.9	18	75	3.2*	2.3	0.6	--	15.5	AC45-22	Arms: 2@ OPAR-12x6
45	42	388	6.9	12.0	18	75	3.2*	3.2*	3.2*	--	15.5	AD45-22	Arms: 2@ OPAR-12x6

■ Standard handhole: 2½" x 5" oval. Handhole covers are polyurethane coated to match pole color. ■ All poles are individually wrapped for shipment. ■ Poles on this page are predrilled for Shakespeare 12' Mast Arms. ■ Aluminum cap standard.

*Poles are not rated above 3.2 EPA because the mast arms are not rated for luminaires greater than 3.2 EPA each. EPA and weight specifications include the arm(s). All EPA recommendations are based on poles with handholes, and include a 30% gust factor.

12' Mast Arm Round Tapered Composite Tuff-Poles®

BA, BB, BC, BD, BH, BS, and BX Series, Direct Burial Base

One or Two Shakespeare 12-foot Mast Arms

**COMPOSITE
TUFF-POLE**

Nominal Mounting Height (ft.)	Shaft Length (ft.)	Pole Weight (lbs.)	POLE DIAMETER		Standard Handhole Location from Base (in.)	SUGGESTED MAXIMUM TOTAL LOADING PER ARM				Suggested Burial Depth (ft.)	BASIC CATALOG NUMBER	Comment	
			Shaft Top (in.)	Shaft Base (in.)		Total Weight (lbs.)	80 MPH EPA* (sq. ft.)	90 MPH EPA* (sq. ft.)	100 MPH EPA* (sq. ft.)				120 MPH EPA* (sq. ft.)
Anchor Base pole with ONE 12-foot Mast Arm													
20	21	77	4.6	7.3	66	75	3.2*	3.2*	3.2*	1.9	4	BH24-12	Arm: OPAR-12
25	27	86	4.5	8.2	78	75	3.2*	1.8	0.6	--	5	BS30-12	Arm: OPAR-12
25	27	111	4.7	8.3	78	75	3.2*	3.2*	3.2*	2.7	5	BH30-12	Arm: OPAR-12
30	32	130	4.7	8.4	78	75	3.2*	3.2*	3.2*	1.4	5	BH35-12	Arm: OPAR-12
35	38	164	6.2	11.3	90	75	3.2*	3.2*	2.1	--	6	BA41-12	Arm: OPAR-12x6
35	38	223	6.4	11.4	90	75	3.2*	3.2*	3.2*	1.9	6	BB41-12	Arm: OPAR-12x6
40	44	187	6.2	11.7	102	75	3.2*	1.9	--	--	7	BA47-12	Arm: OPAR-12x6
40	44	255	6.4	11.8	102	75	3.2*	3.2*	3.2*	--	7	BB47-12	Arm: OPAR-12x6
Anchor Base pole with TWO 12-foot Mast Arms @180°													
25	27	132	4.7	8.3	78	75	3.2*	2.6	1.3	--	5	BH30-22	Arms: 2@ OPAR-12
25	27	164	4.9	8.4	78	75	3.2*	3.2*	2.6	0.5	5	BX30-22	Arms: 2@ OPAR-12
30	32	185	4.9	8.5	78	75	3.2*	2.7	1.4	--	5	BX35-22	Arms: 2@ OPAR-12
30	32	213	6.4	10.6	78	75	3.2*	3.2*	2.4	0.7	5	BB35-22	Arms: 2@ OPAR-12x6
30	32	243	6.6	10.7	78	75	3.2*	3.2*	3.2*	2.0	5	BC35-22	Arms: 2@ OPAR-12x6
35	38	245	6.4	11.4	90	75	3.2*	2.3	0.9	--	6	BB41-22	Arms: 2@ OPAR-12x6
35	38	280	6.6	11.5	90	75	3.2*	3.2*	3.2*	0.6	6	BC41-22	Arms: 2@ OPAR-12x6
40	44	277	6.4	11.8	102	75	2.6	1.0	--	--	7	BB47-22	Arms: 2@ OPAR-12x6
40	44	317	6.6	11.9	102	75	3.2*	3.2*	1.8	--	7	BC47-22	Arms: 2@ OPAR-12x6
40	44	378	6.9	12.0	102	75	3.2*	3.2*	3.2*	0.7	7	BD47-22	Arms: 2@ OPAR-12x6

■ Standard handhole: 2½" x 5" oval. Handhole covers are polyurethane coated to match pole color. ■ All poles are individually wrapped for shipment. ■ Poles on this page are predrilled for Shakespeare 12' Mast Arms. ■ Aluminum cap and wiring access hole standard.

*Poles are not rated above 3.2 EPA because the mast arms are not rated for luminaires greater than 3.2 EPA each. EPA and weight specifications include the arm(s). All EPA recommendations are based on poles with handholes, and include a 30% gust factor.

Mast Arm Composite Tuff-Poles®

Anchor Base

One or Two Shakespeare Truss Style Mast Arms



AB, AC, and AD Series
with 15' Truss Style
Arm(s)

Anchor Base

- Mounting heights to 45'
- Natural or smooth finish
- Three standard and five special colors; architectural colors are available. Pigments and UV inhibitors integrated into the resin
- High-performance UV- and weather resistant pigmented polyurethane coating
- Capped
- Poles predrilled for Shakespeare 15' Truss Style Mast Arms
- Composite shrouds (1- or 2-piece) optional. Optional bolt covers available for some styles
- Poles are individually ID tagged
- Wrapped individually for shipment

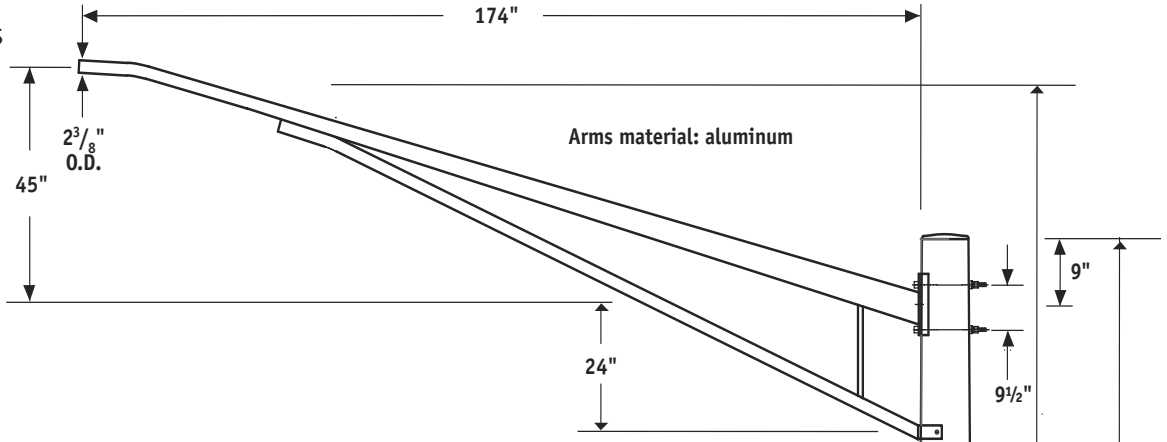

Truss Arm Dimensions

Arm Length	SPAN	RISE
15'	174"	45"

Capped



Series:

AB
AC
AD

Mounting Height

Shaft Length

ANCHOR BASE: Cast A356-T6 aluminum, polyurethane coated to match pole color. Hot dipped galvanized steel anchor bolts complete with nuts (2) and washers (2) are supplied standard (1 1/4" x 36" x 6").

Anchor Base Dimensions

Bolt Hole Circle	Drawing	Square	Slot
14"	B	12.9"	1 1/2" x 2"
14 1/2"	B	13.3"	1 1/2" x 2"
15"	B	13.5"	1 1/2" x 2"
15 1/2"	B	14"	1 1/2" x 2"

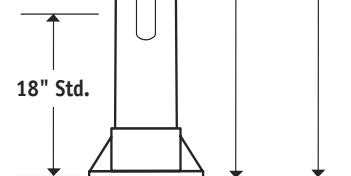
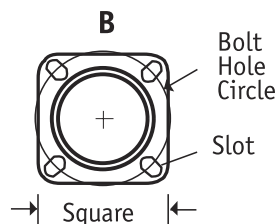

Poles are not rated above 3.2 EPA because the mast arms are not rated for luminaires greater than 3.2 EPA each. EPA and weight specifications include the arm(s). All EPA recommendations, including 120 mph, include a 30% gust factor

15' Mast Arm Round Tapered Composite Tuff-Poles®

AB, AC, and AD Series, Anchor Base

One or Two Shakespeare 15-foot Truss Style Mast Arms

**COMPOSITE
TUFF-POLE**

Nominal Mounting Height (ft.)	Shaft Length (ft.)	Pole Weight (lbs.)	POLE DIAMETER		Standard Handhole Location from Base (in.)	SUGGESTED MAXIMUM TOTAL LOADING PER ARM					Bolt Hole Circle (in.)	BASIC CATALOG NUMBER	Comment
			Shaft Top (in.)	Shaft Base (in.)		Total Weight (lbs.)	80 MPH EPA* (sq. ft.)	90 MPH EPA* (sq. ft.)	100 MPH EPA* (sq. ft.)	120 MPH EPA* (sq. ft.)			
Anchor Base pole with ONE 15-foot Truss Arm													
25	22	175	6.4	9.2	18	75	3.2*	3.2*	3.2*	2.9	14	AB25-15	Arm: OPAR-15x6
30	27	200	6.4	9.9	18	75	3.2*	3.2*	3.2*	0.9	14.5	AB30-15	Arm: OPAR-15X6
35	32	230	6.4	10.6	18	75	3.2*	3.2*	2.6	--	15	AB35-15	Arm: OPAR-15X6
35	32	260	6.6	10.7	18	75	3.2*	3.2*	3.2*	1.9	15	AC35-15	Arm: OPAR-15X6
40	37	258	6.4	11.3	18	75	3.2*	2.9	--	--	15.5	AB40-15	Arm: OPAR-15x6
40	37	293	6.6	11.4	18	75	3.2*	3.2*	3.2*	--	15.5	AC40-15	Arm: OPAR-15x6
45	42	291	6.4	11.8	18	75	3.2*	0.8	--	--	15.5	AB45-15	Arm: OPAR-15x6
45	42	330	6.6	11.9	18	75	3.2*	3.2*	2.2	--	15.5	AC45-15	Arm: OPAR-15x6
45	42	387	6.9	12.0	18	75	3.2*	3.2*	3.2*	--	15.5	AD45-15	Arm: OPAR-15x6
Anchor Base pole with TWO 15-foot Truss Arms @180°													
25	22	213	6.4	9.2	18	75	3.2*	2.5	0.7	--	14	AB25-25	Arms: 2@ OPAR-15x6
25	22	232	6.6	9.4	18	75	3.2*	3.2*	3.2*	--	14	AC25-25	Arms: 2@ OPAR-15x6
30	27	238	6.4	9.9	18	75	3.2*	1.0	--	--	14.5	AB30-25	Arms: 2@ OPAR-15X6
30	27	263	6.6	10.1	18	75	3.2*	3.2*	2.1	--	14.5	AC30-25	Arms: 2@ OPAR-15x6
30	27	300	6.9	10.2	18	75	3.2*	3.2*	3.2*	0.7	14.5	AD30-25	Arms: 2@ OPAR-15x6
35	32	298	6.6	10.7	18	75	3.2*	2.1	--	--	15	AC35-25	Arms: 2@ OPAR-15x6
35	32	342	6.9	10.9	18	75	3.2*	3.2*	2.3	--	15	AD35-25	Arms: 2@ OPAR-15x6
40	37	331	6.6	11.4	18	75	3.2*	0.5	--	--	15.5	AC40-25	Arms: 2@ OPAR-15x6
40	37	387	6.9	11.5	18	75	3.2*	3.0	0.6	--	15.5	AD40-25	Arms: 2@ OPAR-15x6
45	42	425	6.9	12.0	18	75	3.2*	1.5	--	--	15.5	AD45-25	Arms: 2@ OPAR-15x6

■ Standard handhole: 2½" x 5" oval. Optional 4" x 6", 3" x 9", or 4" x 12" handholes, depending on pole dimensions. For other handhole options, contact factory. All handhole covers are polyurethane coated to match pole color.

■ Standard handhole: 2½" x 5" oval. Handhole covers are polyurethane coated to match pole color. ■ All poles are individually wrapped for shipment. ■ Poles on this page are predrilled for Shakespeare 15' Truss Style Mast Arms. ■ Aluminum cap standard.

*Poles are not rated above 3.2 EPA because the mast arms are not rated for luminaires greater than 3.2 EPA each. EPA and weight specifications include the arm(s). All EPA recommendations are based on poles with handholes, and include a 30% gust factor.

Mast Arm Composite Tuff-Poles®

Direct Burial Base

One or Two Shakespeare Truss Style Mast Arms

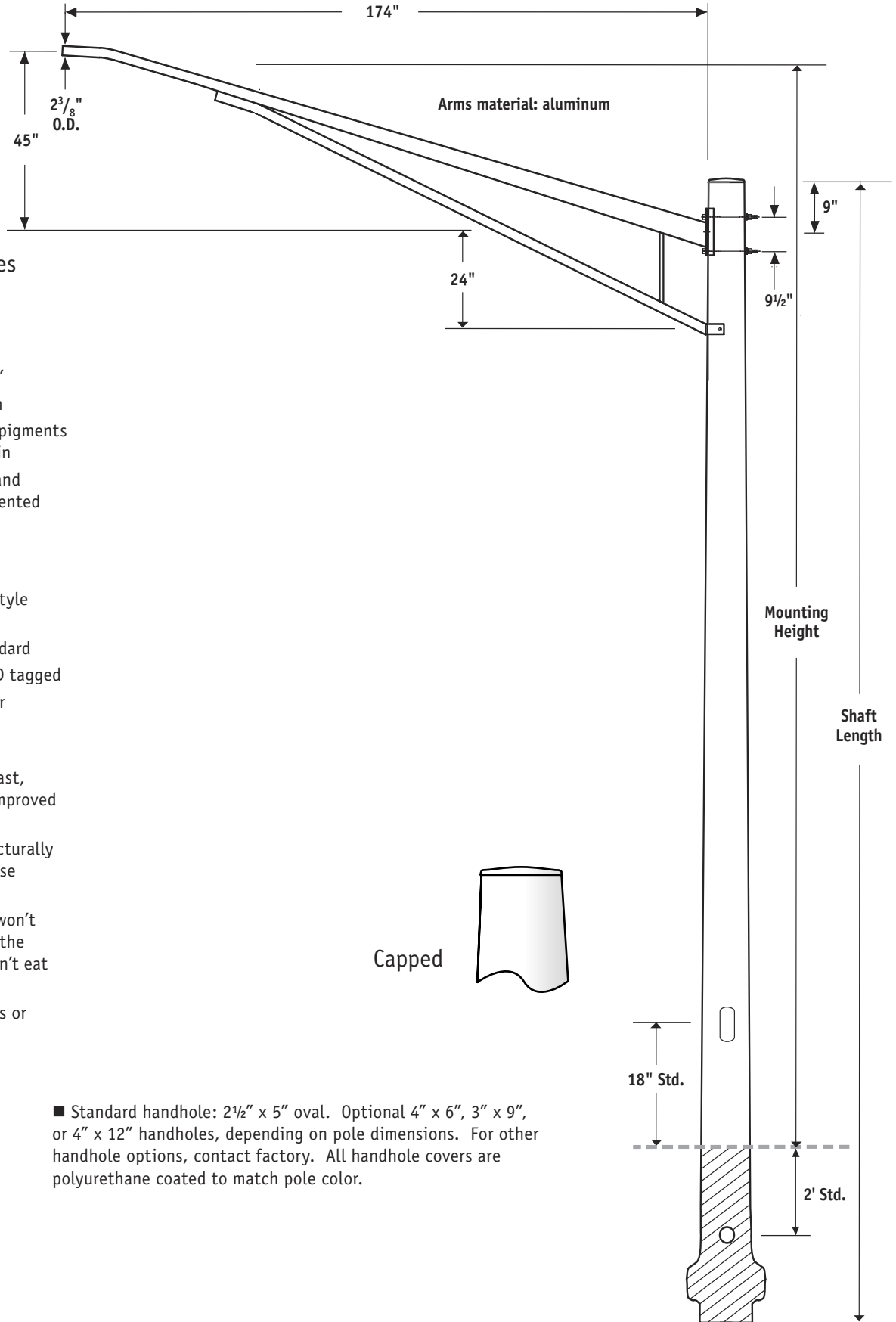

BB, BC, and BD Series

Direct Burial Base

- Mounting heights to 40'
- Natural or smooth finish
- Eight standard colors - pigments integrated into the resin
- High-performance UV- and weather resistant pigmented polyurethane coating
- Capped
- Poles are predrilled for Shakespeare 15' Truss Style Mast Arms
- Wiring access hole standard
- Poles are individually ID tagged
- Wrapped individually for shipment

- Direct Burial style for fast, easy installation and improved ground line appearance
- Anti-rotation flare structurally integrated into pole base during manufacture
- Shakespeare fiberglass won't rust, rot, or corrode in the ground, and insects won't eat it.
- No concrete foundations or anchor bolts

Series: _____

■ Standard handhole: 2½" x 5" oval. Optional 4" x 6", 3" x 9", or 4" x 12" handholes, depending on pole dimensions. For other handhole options, contact factory. All handhole covers are polyurethane coated to match pole color.

BB
BC
BD

Poles are not rated above 3.2 EPA because the mast arms are not rated for luminaires greater than 3.2 EPA each. EPA and weight specifications include the arm(s). All EPA recommendations, including 120 mph, include a 30% gust factor

15' Mast Arm Round Tapered Composite Tuff-Poles®

BB, BC, and BD Series, Direct Burial Base

One or Two Shakespeare 15-foot Truss Style Mast Arms

**COMPOSITE
TUFF-POLE**

Nominal Mounting Height (ft.)	Shaft Length (ft.)	Pole Weight (lbs.)	POLE DIAMETER		Standard Handhole Location from Base (in.)	SUGGESTED MAXIMUM TOTAL LOADING PER ARM				Suggested Burial Depth (ft.)	BASIC CATALOG NUMBER	Comment	
			Shaft Top (in.)	Shaft Base (in.)		Total Weight (lbs.)	80 MPH EPA* (sq. ft.)	90 MPH EPA* (sq. ft.)	100 MPH EPA* (sq. ft.)				120 MPH EPA* (sq. ft.)
Direct Burial Base pole with ONE 15-foot Truss Style Mast Arm													
25	27	183	6.4	9.9	78	75	3.2*	3.2*	3.2*	2.9	5	BB30-15	Arm: OPAR-15x6
30	32	209	6.4	10.6	78	75	3.2*	3.2*	3.2*	0.9	5	BB35-15	Arm: OPAR-15x6
35	38	241	6.4	11.4	90	75	3.2*	3.2*	2.6	--	6	BB41-15	Arm: OPAR-15x6
35	38	277	6.6	11.5	90	75	3.2*	3.2*	3.2*	1.9	6	BC41-15	Arm: OPAR-15x6
40	44	273	6.4	11.8	102	75	3.2*	2.9	--	--	7	BB47-15	Arm: OPAR-15x6
40	44	313	6.6	11.9	102	75	3.2*	3.2*	3.2*	--	7	BC47-15	Arm: OPAR-15x6
Direct Burial Base pole with TWO 15-foot Truss Style Mast Arms @180°													
25	27	223	6.4	9.9	78	75	3.2*	2.5	0.7	--	5	BB30-25	Arms: 2@ OPAR-15x6
25	27	248	6.6	10.1	78	75	3.2*	3.2*	3.2*	--	5	BC30-25	Arms: 2@ OPAR-15x6
30	32	279	6.6	10.7	78	75	3.2*	3.2*	2.1	--	5	BC35-25	Arms: 2@ OPAR-15x6
30	32	323	6.9	10.9	78	75	3.2*	3.2*	3.2*	0.7	5	BD35-25	Arms: 2@ OPAR-15x6
35	38	317	6.6	11.5	90	75	3.2*	2.1	--	--	6	BC41-25	Arms: 2@ OPAR-15x6
35	38	368	6.9	11.6	90	75	3.2*	3.2*	2.3	--	6	BD41-25	Arms: 2@ OPAR-15x6
40	44	353	6.6	11.9	102	75	3.0	0.5	--	--	7	BC47-25	Arms: 2@ OPAR-15x6
40	44	414	6.9	12.0	102	75	3.2*	3.0	0.6	--	7	BD47-25	Arms: 2@ OPAR-15x6

For EPA specifications for poles without arms, see Round Tapered Poles.

■ Standard handhole: 2½" x 5" oval. Handhole covers are polyurethane coated to match pole color. ■ All poles are individually wrapped for shipment. ■ Poles on this page are predrilled for Shakespeare 15' Truss Style Mast Arms. ■ Aluminum cap and wiring access hole standard. *Poles are not rated above 3.2 EPA because the mast arms are not rated for luminaires greater than 3.2 EPA each. EPA and weight specifications include the arm(s). All EPA recommendations are based on poles with handholes, and include a 30% gust factor.



Notes:

Breakaway Tuff-Poles®



Breakaway





AHW, and ASW Series Breakaway Poles

BAW, BBW, BCW, BHW, BSW and BXW Series Breakaway Poles

Anchor Base and Direct Burial

Anchor Base

- Mounting heights of 27' to 35'
- No additional hardware or field assembly required for Breakaway poles
- Accepted per AASHTO Breakaway Specifications by the Federal Highway Administration
- Natural or smooth finish
- Three standard and five special colors; architectural colors are available. Pigments and UV inhibitors integrated into the resin
- High-performance UV- and weather resistant pigmented polyurethane coating
- Capped or Tenon Top construction. EPA ratings are the same for Capped or Tenon Top poles.
- Poles can be predrilled for bolt-on side mount fixture(s), arms, etc.
- Poles are individually ID tagged
- Wrapped individually for shipment

Direct Burial Base

- Mounting heights to 40'
- Natural or smooth finish
- No additional hardware or field assembly required for Breakaway poles
- Accepted per AASHTO Breakaway Specifications by the Federal Highway Administration
- Three standard and five special colors; architectural colors are available. Pigments and UV inhibitors integrated into the resin
- High-performance UV- and weather resistant pigmented polyurethane coating
- Capped or Tenon Top construction. EPA ratings are the same for Capped or Tenon Top poles.
- Poles can be predrilled for bolt-on side mount fixture(s), arms, etc.
- Wiring access hole standard
- Poles are individually ID tagged
- Wrapped individually for shipment
- Direct Burial style for fast, easy installation and improved ground line appearance
- Anti-rotation flare structurally integrated into pole base during manufacture
- Shakespeare fiberglass won't rust, rot, or corrode in the ground, and insects won't eat it.
- No concrete foundations or anchor bolts

Capped and Tenon Top

	Page
Breakaway Poles	46

Series: _____

- AHW BAW
- ASW BBW
- BCW
- BHW
- BSW
- BXW

■ Standard handhole: 2½" x 5" oval. All handhole covers are polyurethane coated to match pole color. ■ EPA ratings are the same for capped or tenon top poles. ■ Poles can be predrilled for bolt-on side mount fixture(s), arms, brackets, etc.
 *All EPA recommendations are based on poles with handholes, and include a 30% gust factor.

Breakaway Composite Tuff-Poles®

Anchor Base and Direct Burial Base

Tenon Top and Capped

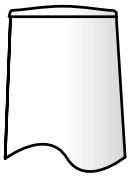

Capped

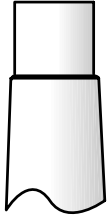

TENONS: $2\frac{3}{8}$ ", 3", 4" OD, if pole dimensions permit. Tenons are A356-T6 aluminum or hot-dipped galvanized steel, and are available in all standard sizes; for other optional tenons contact Shakespeare. Post top fixtures, flood lights, or brackets mount with ease.

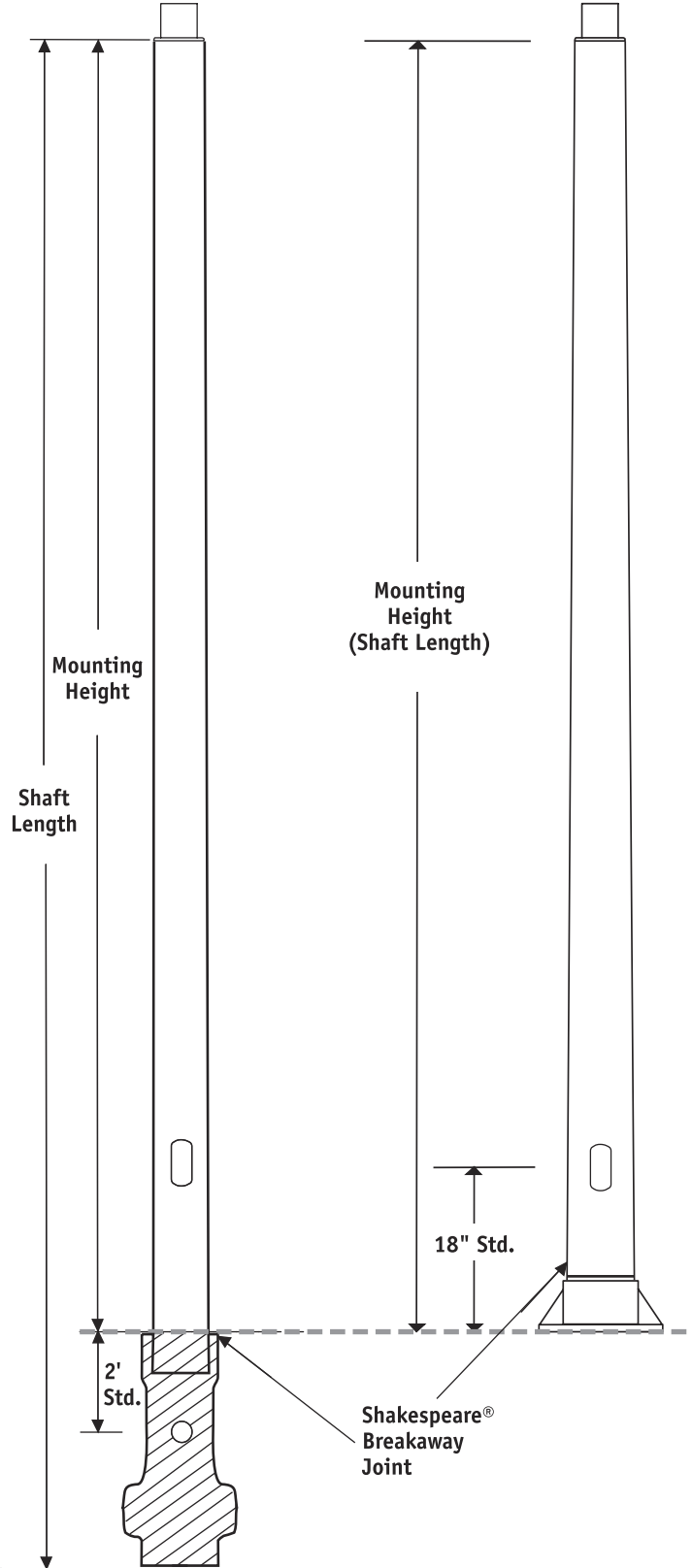

ANCHOR BASE: Cast A356-T6 aluminum, polyurethane coated to match pole color.

Hot dipped galvanized steel anchor bolts complete with nuts (2) and washers (2) are supplied standard (1" x 30" x 4").

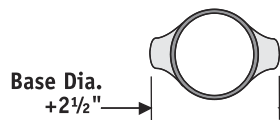
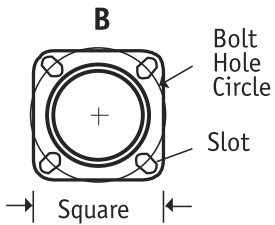

Anchor Base Dimensions

Bolt Hole Circle	Drawing	Square	Slot
1 1/2"	B	11"	1 1/4" x 1 3/4"

Breakaway Composite Tuff-Poles®

BAW, BBW, BCW, BHW, BSW, and BXW Series Direct Burial Base

Tenon Top or Capped

**COMPOSITE
TUFF-POLE**

Nominal Mounting Height (ft.)	Shaft Length (ft.)	Pole Weight (lbs.)	POLE DIAMETER		Standard Handhole Location from Base (in.)	SUGGESTED MAXIMUM TOTAL LOADING					Suggested Burial Depth (ft.)	BASIC CATALOG NUMBER	Comment
			Shaft Top (in.)	Shaft Base (in.)		Total Weight (lbs.)	80 MPH EPA* (sq. ft.)	90 MPH EPA* (sq. ft.)	100 MPH EPA* (sq. ft.)	120 MPH EPA* (sq. ft.)			
BREAKAWAY Round Tapered Direct Burial Base pole													
16	20	52	4.6	7.3	66	200	16.2	12.6	10.1	6.7	4	BHW20	
20	24	62	4.6	7.3	66	200	11.2	8.6	6.8	4.5	4	BHW24	
25	30	71	4.5	8.3	78	100	6.2	4.7	3.6	2.2	5	BSW30	
25	30	98	4.7	8.4	78	200	14.5	11.2	8.9	5.9	5	BHW30	
25	30	132	4.9	8.5	78	300	20.1	15.7	12.5	8.2	5	BSW30	
25	30	159	6.4	10.3	78	300	23.2	18.2	14.3	9.0	5	BBW30	
25	30	187	6.6	10.4	78	300	33.5	26.2	20.8	13.6	5	BCW30	
30	35	82	4.5	8.3	78	100	3.7	2.6	1.9	0.8	5	BSW35	
30	35	116	4.7	8.4	78	200	10.5	8.0	6.2	3.8	5	BHW35	
30	35	153	4.9	8.5	78	300	14.8	11.4	9.0	5.6	5	BXW35	
30	35	186	6.4	11.0	78	300	19.7	16.2	11.7	7.1	5	BBW35	
30	35	218	6.6	11.1	78	300	28.7	22.4	17.4	11.0	5	BCW35	
35	41	154	6.2	11.7	90	300	8.1	6.0	3.9	1.3	6	BAW41	
35	41	218	6.4	11.8	90	300	14.3	10.8	7.8	4.0	6	BBW41	
35	41	256	6.6	11.9	90	300	21.8	16.6	12.5	7.2	6	BCW41	
40	47	176	6.2	11.7	102	300	6.4	4.3	2.4	--	7	BAW47	
40	47	249	6.4	11.8	102	300	12.2	8.8	6.0	2.5	7	BBW47	
40	47	292	6.6	11.9	102	300	19.2	14.1	10.4	5.4	7	BCW47	

ALL POLES LISTED ON THIS PAGE HAVE BEEN ACCEPTED

PER THE 1985 AASHTO BREAKAWAY SPECIFICATIONS BY THE FEDERAL HIGHWAY ADMINISTRATION

■ Standard handhole: 2½" x 5" oval. Handhole covers are polyurethane coated to match pole color. ■ All poles are individually wrapped for shipment. ■ Poles can be predrilled for bolt-on side mount fixture(s), arms, brackets, etc. ■ EPA ratings are the same for capped or tenon top poles.

*All EPA recommendations are based on poles with handholes, and include a 30% gust factor.

Breakaway Composite Tuff-Poles®

AHW and ASW Series Anchor Base

Tenon Top or Capped



Nominal Mounting Height (ft.)	Shaft Length (ft.)	Pole Weight (lbs.)	POLE DIAMETER		Standard Handhole Location from Base (in.)	SUGGESTED MAXIMUM TOTAL LOADING					Bolt Hole Circle (in.)	BASIC CATALOG NUMBER	Comment
			Shaft Top (in.)	Shaft Base (in.)		Total Weight (lbs.)	80 MPH EPA* (sq. ft.)	90 MPH EPA* (sq. ft.)	100 MPH EPA* (sq. ft.)	120 MPH EPA* (sq. ft.)			
BREAKAWAY Round Tapered Anchor Base pole													
27	27	99	4.7	8.3	18	100	14.3	11.0	8.7	5.7	11.5	ASW27	
27	27	138	4.9	8.4	18	200	18.9	14.7	11.7	7.7	11.5	AHW27	
28	28	102	4.7	8.4	18	100	13.4	10.3	8.1	5.3	11.5	ASW28	
28	28	143	4.9	8.5	18	200	17.9	13.9	11.0	7.3	11.5	AHW28	
29	29	106	4.7	8.4	18	100	12.6	9.7	7.6	4.9	11.5	ASW29	
29	29	147	4.9	8.4	18	200	16.9	13.1	10.4	6.8	11.5	AHW29	
30	30	108	4.7	8.4	18	100	11.9	9.1	7.1	4.6	11.5	ASW30	
30	30	153	4.9	8.5	18	200	16.0	12.3	9.8	6.3	11.5	AHW30	
31	31	112	4.7	8.4	18	100	10.1	7.7	6.0	3.8	11.5	ASW31	
31	31	158	4.9	8.5	18	200	13.7	10.6	8.3	5.4	11.5	AHW31	
32	32	115	4.7	8.4	18	100	9.5	7.2	5.6	3.5	11.5	ASW32	
32	32	162	4.9	8.5	18	200	13.0	10.0	7.8	5.0	11.5	AHW32	
33	33	118	4.7	8.4	18	100	8.9	6.7	5.2	3.2	11.5	ASW33	
33	33	167	4.9	8.5	18	200	12.3	9.4	7.4	4.6	11.5	AHW33	
34	34	122	4.4	8.4	18	100	7.1	5.2	3.9	2.2	11.5	ASW34	
34	34	172	4.9	8.5	18	200	10.4	7.8	6.0	3.6	11.5	AHW34	
35	35	126	4.7	8.4	18	100	5.5	3.8	2.7	1.3	11.5	ASW35	
35	35	164	4.9	8.5	18	200	9.7	7.2	5.5	3.2	11.5	AHW35	

For EPA specifications for Breakaway poles with arms, see Breakaway Mast Arm Poles.

See OPTIONS AND ACCESSORIES for hardware, arms, etc.

- Standard handhole: 2½" x 5" oval. Optional 4" x 6", 3" x 9", or 4" x 12" handholes, depending on pole dimensions. For other handhole options, contact factory. All handhole covers are polyurethane coated to match pole color.

**ALL POLES LISTED ON THIS PAGE HAVE BEEN ACCEPTED
PER THE 1985 AASHTO BREAKAWAY SPECIFICATIONS BY THE FEDERAL HIGHWAY ADMINISTRATION**

- Standard handhole: 2½" x 5" oval. Handhole covers are polyurethane coated to match pole color.
- All poles are individually wrapped for shipment.
- Poles can be predrilled for bolt-on side mount fixture(s), arms, brackets, etc.
- EPA ratings are the same for capped or tenon top poles.

*All EPA recommendations are based on poles with handholes, and include a 30% gust factor.

Breakaway Tuff-Poles[®] with Mast Arms



Breakaway + Arms



Shakespeare
Composite Structures



Breakaway Composite Tuff-Poles® with Mast Arms



AHW, and ASW Series Breakaway Poles with Mast Arm(s)

BAW, BBW, BCW, BHW, BSW and BXW Series Breakaway Poles with Mast Arm(s)

Anchor Base and Direct Burial

Anchor Base

Direct Burial Base

Capped

- Mounting heights of 27' to 35'
- No additional hardware or field assembly required for Breakaway poles
- Accepted per AASHTO Breakaway Specifications by the Federal Highway Administration
- Natural or smooth finish
- Three standard and five special colors; architectural colors are available. Pigments and UV inhibitors integrated into the resin
- High-performance UV- and weather resistant pigmented polyurethane coating
- Capped construction.
- Poles predrilled for Shakespeare Mast Arms
- Poles are individually ID tagged
- Wrapped individually for shipment

- Mounting heights to 40'
- Natural or smooth finish
- No additional hardware or field assembly required for Breakaway poles
- Accepted per AASHTO Breakaway Specifications by the Federal Highway Administration
- Three standard and five special colors; architectural colors are available. Pigments and UV inhibitors integrated into the resin
- High-performance UV- and weather resistant pigmented polyurethane coating
- Capped construction.
- Poles predrilled for Shakespeare Mast Arms
- Wiring access hole standard
- Poles are individually ID tagged
- Wrapped individually for shipment
- Direct Burial style for fast, easy installation and improved ground line appearance
- Anti-rotation flare structurally integrated into pole base during manufacture
- Shakespeare fiberglass won't rust, rot, or corrode in the ground, and insects won't eat it.
- No concrete foundations or anchor bolts

Page

Breakaway Poles with:

4' Mast Arms	52
6' Mast Arms	54
8' Mast Arms	57
10' Mast Arms	60
12' Mast Arms	63
15' Mast Arms	67

For Breakaway poles without arms, see Breakaway Poles.

Series:

■ Standard handhole: 2½" x 5" oval. Optional 4" x 6", 3" x 9", or 4" x 12" handholes, depending on pole dimensions. For other handhole options, contact factory. All handhole covers are polyurethane coated to match pole color.

- AHW
- ASW
- BAW
- BBW
- BCW
- BHW
- BSW
- BXW

■ Standard handhole: 2½" x 5" oval. Handhole covers are polyurethane coated to match pole color. ■ All poles are individually wrapped for shipment. ■ This series is predrilled for Shakespeare Mast Arms.

*Poles are not rated above 3.2 EPA because the mast arms are not rated for luminaires greater than 3.2 EPA each. EPA and weight specifications include the arm(s). All EPA recommendations are based on poles with handholes, and include a 30% gust factor.

Breakaway Mast Arm Composite Tuff-Poles®

Anchor Base and Direct Burial Base

Shakespeare Mast Arms

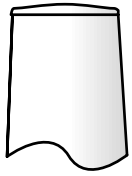

Capped

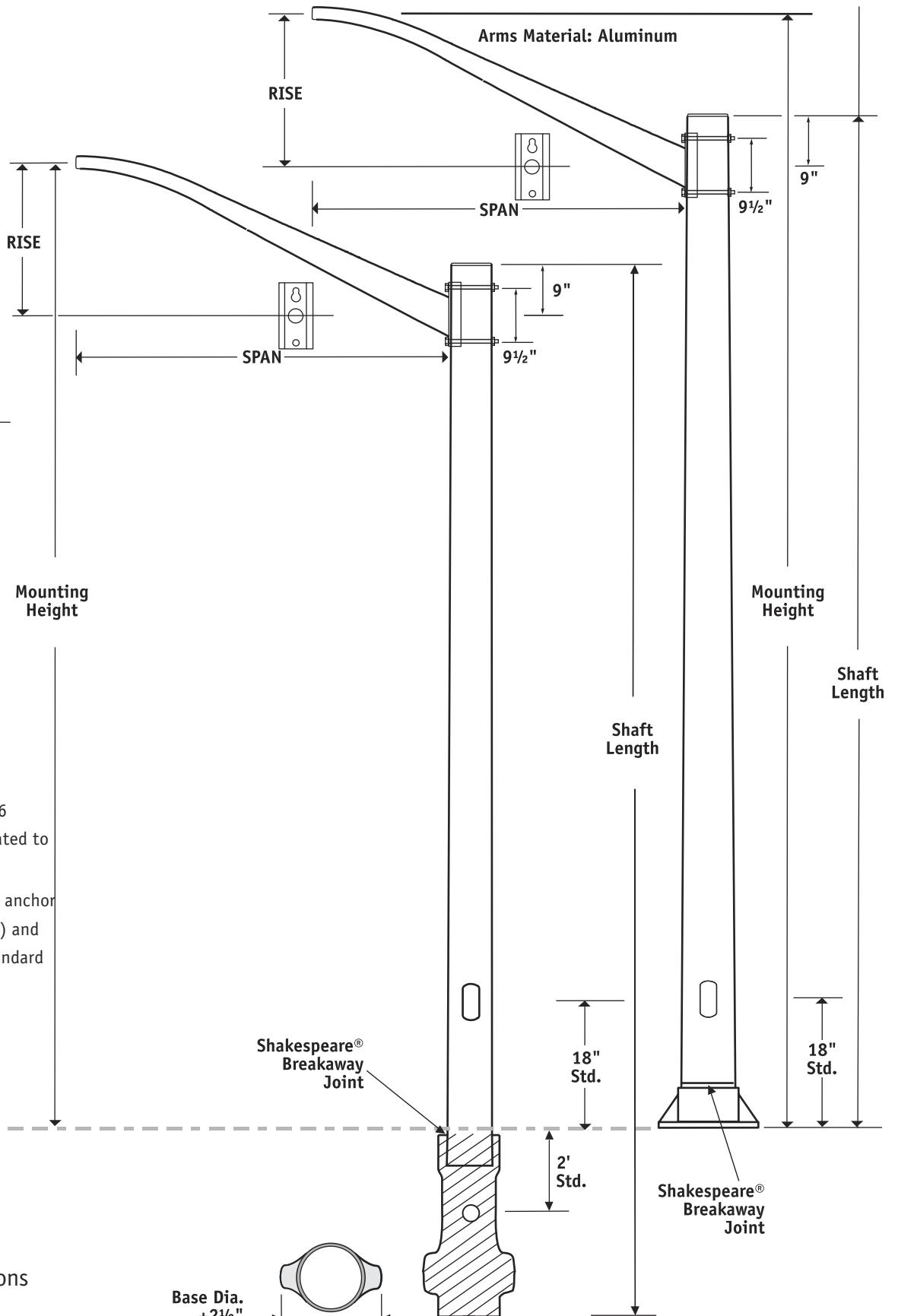

Arm Dimensions

Arm Length	SPAN	RISE
4'	45"	15"
6'	68"	24"
8'	90"	33"
10'	120"	39"
12'	138"	45"
15'	174"	45"

ANCHOR BASE: Cast A356-T6 aluminum, polyurethane coated to match pole color.

Hot dipped galvanized steel anchor bolts complete with nuts (2) and washers (2) are supplied standard (1" x 30" x 4").

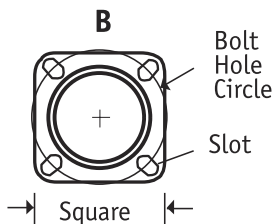

Anchor Base Dimensions

Bolt Hole Circle	Drawing	Square	Slot
11 1/2"	B	11"	1 1/4" x 1 3/4"

Base Dia. +2 1/2"

Notes:

Poles are not rated above 3.2 EPA because the mast arms are not rated for luminaires greater than 3.2 EPA each. EPA and weight specifications include the arm(s). All EPA recommendations, including 120 mph, are calculated to include a 30% gust factor

Breakaway 4' Mast Arm Composite Tuff-Poles®

AHW and ASW Series Anchor Base

One or Two Shakespeare 4-foot Mast Arms



Nominal Mounting Height (ft.)	Shaft Length (ft.)	Pole Weight (lbs.)	POLE DIAMETER		Standard Handhole Location from Base (in.)	SUGGESTED MAXIMUM TOTAL LOADING PER ARM				Bolt Hole Circle (in.)	BASIC CATALOG NUMBER	Comment	
			Shaft Top (in.)	Shaft Base (in.)		Total Weight (lbs.)	80 MPH EPA* (sq. ft.)	90 MPH EPA* (sq. ft.)	100 MPH EPA* (sq. ft.)				120 MPH EPA* (sq. ft.)
BREAKAWAY Round Tapered Anchor Base pole with ONE 4-foot Mast Arm													
27	26.5	101	4.7	8.2	18	75	3.2*	3.2*	3.2*	3.2*	11.5	ASW27-14	Arm: OPAR-4
27	26.5	134	4.9	8.4	18	75	3.2*	3.2*	3.2*	3.2*	11.5	AHW27-14	Arm: OPAR-4
28	27.5	104	4.7	8.3	18	75	3.2*	3.2*	3.2*	3.2*	11.5	ASW28-14	Arm: OPAR-4
28	27.5	139	4.9	8.4	18	75	3.2*	3.2*	3.2*	3.2*	11.5	AHW28-14	Arm: OPAR-4
29	28.5	108	4.7	8.4	18	75	3.2*	3.2*	3.2*	3.2*	11.5	ASW29-14	Arm: OPAR-4
29	28.5	143	4.9	8.5	18	75	3.2*	3.2*	3.2*	3.2*	11.5	AHW29-14	Arm: OPAR-4
30	29.5	111	4.7	8.4	18	75	3.2*	3.2*	3.2*	3.2*	11.5	ASW30-14	Arm: OPAR-4
30	29.5	148	4.9	8.5	18	75	3.2*	3.2*	3.2*	3.2*	11.5	AHW30-14	Arm: OPAR-4
31	30.5	114	4.7	8.4	18	75	3.2*	3.2*	3.2*	3.1	11.5	ASW31-14	Arm: OPAR-4
31	30.5	153	4.9	8.5	18	75	3.2*	3.2*	3.2*	3.2*	11.5	AHW31-14	Arm: OPAR-4
32	31.5	119	4.7	8.4	18	75	3.2*	3.2*	3.2*	2.8	11.5	ASW32-14	Arm: OPAR-4
32	31.5	156	4.9	8.5	18	75	3.2*	3.2*	3.2*	3.2*	11.5	AHW32-14	Arm: OPAR-4
33	32.5	122	4.7	8.4	18	75	3.2*	3.2*	3.2*	2.5	11.5	ASW33-14	Arm: OPAR-4
33	32.5	161	4.9	8.5	18	75	3.2*	3.2*	3.2*	3.2*	11.5	AHW33-14	Arm: OPAR-4
34	33.5	127	4.7	8.4	18	75	3.2*	3.2*	3.2*	1.5	11.5	ASW34-14	Arm: OPAR-4
34	33.5	166	4.9	8.5	18	75	3.2*	3.2*	3.2*	3.0	11.5	AHW34-14	Arm: OPAR-4
35	34.5	131	4.7	8.4	18	75	3.2*	3.2*	2.8	1.2	11.5	ASW35-14	Arm: OPAR-4
35	34.5	158	4.9	8.5	18	75	3.2*	3.2*	3.2*	3.2*	11.5	AHW35-14	Arm: OPAR-4
BREAKAWAY Round Tapered Anchor Base pole with TWO 4-foot Mast Arms @180°													
27	26.5	107	4.7	8.2	18	75	3.2*	3.2*	3.2*	1.9	11.5	ASW27-24	Arms: 2@ OPAR-4
27	26.5	140	4.9	8.4	18	75	3.2*	3.2*	3.2*	3.0	11.5	AHW27-24	Arms: 2@ OPAR-4
28	27.5	110	4.7	8.3	18	75	3.2*	3.2*	3.2*	1.8	11.5	ASW28-24	Arms: 2@ OPAR-4
28	27.5	145	4.9	8.4	18	75	3.2*	3.2*	3.2*	2.8	11.5	AHW28-24	Arms: 2@ OPAR-4
29	28.5	114	4.7	8.4	18	75	3.2*	3.2*	2.9	1.6	11.5	ASW29-24	Arms: 2@ OPAR-4
29	28.5	149	4.9	8.5	18	75	3.2*	3.2*	3.2*	2.6	11.5	AHW29-24	Arms: 2@ OPAR-4
30	29.5	117	4.7	8.4	18	75	3.2*	3.2*	2.6	1.4	11.5	ASW30-24	Arms: 2@ OPAR-4
30	29.5	154	4.9	8.5	18	75	3.2*	3.2*	3.2*	2.4	11.5	AHW30-24	Arms: 2@ OPAR-4
31	30.5	120	4.7	8.4	18	75	3.2*	2.9	2.1	1.0	11.5	ASW31-24	Arms: 2@ OPAR-4
31	30.5	159	4.9	8.5	18	75	3.2*	3.2*	3.2*	1.9	11.5	AHW31-24	Arms: 2@ OPAR-4
32	31.5	125	4.7	8.4	18	75	3.2*	2.7	1.9	0.9	11.5	ASW32-24	Arms: 2@ OPAR-4
32	31.5	162	4.9	8.5	18	75	3.2*	3.2*	3.2*	1.7	11.5	AHW32-24	Arms: 2@ OPAR-4
33	32.5	128	4.7	8.4	18	75	3.2*	2.4	1.7	0.7	11.5	ASW33-24	Arms: 2@ OPAR-4
33	32.5	167	4.9	8.5	18	75	3.2*	3.2*	2.9	1.5	11.5	AHW33-24	Arms: 2@ OPAR-4
34	33.5	133	4.7	8.4	18	75	3.2*	1.7	1.1	--	11.5	ASW34-24	Arms: 2@ OPAR-4
34	33.5	172	4.9	8.5	18	75	3.2*	3.2*	2.3	1.0	11.5	AHW34-24	Arms: 2@ OPAR-4
35	34.5	137	4.7	8.4	18	75	2.3	1.5	0.9	--	11.5	ASW35-24	Arms: 2@ OPAR-4
35	34.5	164	4.9	8.5	18	75	3.2*	2.9	2.0	0.8	11.5	AHW35-24	Arms: 2@ OPAR-4

ALL POLES LISTED ON THIS PAGE HAVE BEEN ACCEPTED

PER THE 1985 AASHTO BREAKAWAY SPECIFICATIONS BY THE FEDERAL HIGHWAY ADMINISTRATION

■ Standard handhole: 2½" x 5" oval. Handhole covers are polyurethane coated to match pole color. ■ All poles are individually wrapped for shipment. ■ Poles on this page are predrilled for Shakespeare 4' Mast Arms. ■ Aluminum cap standard. ■ EPA and weight specifications include the arm(s). All EPA recommendations are based on poles with handholes, and include a 30% gust factor.

*Poles are not rated above 3.2 EPA because the mast arms are not rated for luminaires greater than 3.2 EPA each.

Breakaway 4' Mast Arm Composite Tuff-Poles®

BAW, BBW, BCW, BHW, BSW, and BXW Series Direct Burial Base

One or Two Shakespeare 4-foot Mast Arms

**COMPOSITE
TUFF-POLE**

Nominal Mounting Height (ft.)	Shaft Length (ft.)	Pole Weight (lbs.)	POLE DIAMETER		Standard Handhole Location from Base (in.)	SUGGESTED MAXIMUM TOTAL LOADING PER ARM					Suggested Burial Depth (ft.)	BASIC CATALOG NUMBER	Comment
			Shaft Top (in.)	Shaft Base (in.)		Total Weight (lbs.)	80 MPH EPA* (sq. ft.)	90 MPH EPA* (sq. ft.)	100 MPH EPA* (sq. ft.)	120 MPH EPA* (sq. ft.)			
BREAKAWAY Round Tapered Direct Burial Base pole with ONE 4-foot Mast Arm													
25	29.5	77	4.5	8.2	78	75	3.2 *	3.2 *	2.9	1.5	5	BSW30-14	Arm: OPAR-4
30	34.5	88	4.5	8.3	78	75	3.1	1.9	1.2	--	5	BSW35-14	Arm: OPAR-4
30	34.5	122	4.7	8.4	78	75	3.2 *	3.2 *	3.2 *	3.2 *	5	BHW35-14	Arm: OPAR-4
35	40.5	158	6.2	11.6	90	75	3.2 *	3.2 *	3.2 *	1.0	6	BAW41-14	Arm: OPAR-4x6
40	46.5	180	6.2	11.7	102	75	3.2 *	3.2 *	2.4	--	7	BAW47-14	Arm: OPAR-4x6
40	46.5	253	6.4	11.8	102	75	3.2 *	3.2 *	3.2 *	2.1	7	BBW47-14	Arm: OPAR-4x6
BREAKAWAY Round Tapered Direct Burial Base pole with TWO 4-foot Mast Arms @180°													
20	23.5	70	4.6	7.3	66	75	3.2 *	3.2 *	2.7	1.6	4	BHW24-24	Arms: 2@ OPAR-4
25	29.5	82	4.5	8.2	78	75	2.2	1.4	0.9	--	5	BSW30-24	Arms: 2@ OPAR-4
25	29.5	109	4.7	8.4	78	75	3.2 *	3.2 *	3.2 *	2.2	5	BHW30-24	Arms: 2@ OPAR-4
30	34.5	128	4.7	8.4	78	75	3.2 *	3.2 *	2.8	1.4	5	BHW35-24	Arms: 2@ OPAR-4
30	34.5	156	4.9	8.5	78	75	3.2 *	3.2 *	3.2 *	2.4	5	BXW35-24	Arms: 2@ OPAR-4
35	40.5	163	6.2	11.6	90	75	3.2 *	2.4	1.4	--	6	BAW41-24	Arms: 2@ OPAR-4x6
35	40.5	226	6.4	11.7	90	75	3.2 *	3.2 *	3.2 *	1.3	6	BBW41-24	Arms: 2@ OPAR-4x6
40	46.5	186	6.2	11.7	102	75	2.7	1.6	0.6	--	7	BAW47-24	Arms: 2@ OPAR-4x6
40	46.5	258	6.4	11.8	102	75	3.2 *	3.2 *	2.4	0.5	7	BBW47-24	Arms: 2@ OPAR-4x6
40	46.5	300	6.6	11.9	102	75	3.2 *	3.2 *	3.2 *	2.0	7	BCW47-24	Arms: 2@ OPAR-4x6

**ALL POLES LISTED ON THIS PAGE HAVE BEEN ACCEPTED
PER THE 1985 AASHTO BREAKAWAY SPECIFICATIONS BY THE FEDERAL HIGHWAY ADMINISTRATION**

■ Standard handhole: 2½" x 5" oval. Handhole covers are polyurethane coated to match pole color. ■ All poles are individually wrapped for shipment. ■ Poles on this page are predrilled for Shakespeare 4' Mast Arms. ■ Aluminum cap and wiring access hole standard. *Poles are not rated above 3.2 EPA because the mast arms are not rated for luminaires greater than 3.2 EPA each. EPA and weight specifications include the arm(s). All EPA recommendations are based on poles with handholes, and include a 30% gust factor.

Breakaway 6' Mast Arm Composite Tuff-Poles®

AHW and ASW Series Anchor Base

One or Two Shakespeare 6-foot Mast Arms



Nominal Mounting Height (ft.)	Shaft Length (ft.)	Pole Weight (lbs.)	POLE DIAMETER		Standard Handhole Location from Base (in.)	SUGGESTED MAXIMUM TOTAL LOADING PER ARM					Bolt Hole Circle (in.)	BASIC CATALOG NUMBER	Comment
			Shaft Top (in.)	Shaft Base (in.)		Total Weight (lbs.)	80 MPH EPA* (sq. ft.)	90 MPH EPA* (sq. ft.)	100 MPH EPA* (sq. ft.)	120 MPH EPA* (sq. ft.)			
BREAKAWAY Round Tapered Anchor Base pole with ONE 6-foot Mast Arm													
27	26	105	4.7	8.2	18	75	3.2*	3.2*	3.2*	3.2*	11.5	ASW27-16	Arm: OPAR-6
27	26	137	4.9	8.3	18	75	3.2*	3.2*	3.2*	3.2*	11.5	AHW27-16	Arm: OPAR-6
28	27	108	4.7	8.3	18	75	3.2*	3.2*	3.2*	3.2*	11.5	ASW28-16	Arm: OPAR-6
28	27	141	4.9	8.4	18	75	3.2*	3.2*	3.2*	3.2*	11.5	AHW28-16	Arm: OPAR-6
29	28	118	4.7	8.4	18	75	3.2*	3.2*	3.2*	3.2*	11.5	ASW29-16	Arm: OPAR-6
29	28	146	4.9	8.5	18	75	3.2*	3.2*	3.2*	3.2*	11.5	AHW29-16	Arm: OPAR-6
30	29	116	4.7	8.4	18	75	3.2*	3.2*	3.2*	3.2*	11.5	ASW30-16	Arm: OPAR-6
30	29	156	4.9	8.5	18	75	3.2*	3.2*	3.2*	3.2*	11.5	AHW30-16	Arm: OPAR-6
31	30	119	4.7	8.4	18	75	3.2*	3.2*	3.2*	2.7	11.5	ASW31-16	Arm: OPAR-6
31	30	154	4.9	8.5	18	75	3.2*	3.2*	3.2*	3.2*	11.5	AHW31-16	Arm: OPAR-6
32	31	124	4.7	8.4	18	75	3.2*	3.2*	3.2*	2.2	11.5	ASW32-16	Arm: OPAR-6
32	31	152	4.9	8.5	18	75	3.2*	3.2*	3.2*	3.2*	11.5	AHW32-16	Arm: OPAR-6
33	32	127	4.7	8.4	18	75	3.2*	3.2*	3.2*	1.9	11.5	ASW33-16	Arm: OPAR-6
33	32	163	4.9	8.5	18	75	3.2*	3.2*	3.2*	3.2*	11.5	AHW33-16	Arm: OPAR-6
34	33	132	4.4	8.4	18	75	3.2*	3.2*	3.2*	1.6	11.5	ASW34-16	Arm: OPAR-6
34	33	167	4.9	8.5	18	75	3.2*	3.2*	3.2*	3.0	11.5	AHW34-16	Arm: OPAR-6
35	34	129	4.7	8.4	18	75	3.2*	3.2*	2.3	0.7	11.5	ASW35-16	Arm: OPAR-6
35	34	171	4.9	8.5	18	75	3.2*	3.2*	3.2*	3.2*	11.5	AHW35-16	Arm: OPAR-6
BREAKAWAY Round Tapered Anchor Base pole with TWO 6-foot Mast Arms @ 180°													
27	26	115	4.7	8.2	18	75	3.2*	3.2*	3.2*	1.3	11.5	ASW27-26	Arms: 2@ OPAR-6
27	26	147	4.9	8.3	18	75	3.2*	3.2*	3.2*	2.4	11.5	AHW27-26	Arms: 2@ OPAR-6
28	27	118	4.7	8.3	18	75	3.2*	3.2*	2.5	1.1	11.5	ASW28-26	Arms: 2@ OPAR-6
28	27	151	4.9	8.4	18	75	3.2*	3.2*	3.2*	2.2	11.5	AHW28-26	Arms: 2@ OPAR-6
29	28	123	4.7	8.4	18	75	3.2*	3.2*	2.3	1.0	11.5	ASW29-26	Arms: 2@ OPAR-6
29	28	156	4.9	8.5	18	75	3.2*	3.2*	3.2*	2.0	11.5	AHW29-26	Arms: 2@ OPAR-6
30	29	126	4.7	8.4	18	75	3.2*	3.0	2.0	0.8	11.5	ASW30-26	Arms: 2@ OPAR-6
30	29	160	4.9	8.5	18	75	3.2*	3.2*	3.2*	1.8	11.5	AHW30-26	Arms: 2@ OPAR-6
31	30	179	4.7	8.4	18	75	3.2*	2.5	1.6	0.5	11.5	ASW31-26	Arms: 2@ OPAR-6
31	30	164	4.9	8.5	18	75	3.2*	3.2*	3.0	1.4	11.5	AHW31-26	Arms: 2@ OPAR-6
32	31	154	4.7	8.4	18	75	3.2*	2.1	1.3	--	11.5	ASW32-26	Arms: 2@ OPAR-6
32	31	169	4.9	8.5	18	75	3.2*	3.2*	2.6	1.1	11.5	AHW32-26	Arms: 2@ OPAR-6
33	32	137	4.7	8.4	18	75	2.9	1.8	1.1	--	11.5	ASW33-26	Arms: 2@ OPAR-6
33	32	173	4.9	8.5	18	75	3.2*	3.2*	2.3	0.9	11.5	AHW33-26	Arms: 2@ OPAR-6
34	33	142	4.4	8.4	18	75	2.6	1.6	0.9	--	11.5	ASW34-26	Arms: 2@ OPAR-6
34	33	177	4.9	8.5	18	75	3.2*	3.1	2.1	0.7	11.5	AHW34-26	Arms: 2@ OPAR-6
35	34	139	4.7	8.4	18	75	1.8	0.9	--	--	11.5	ASW35-26	Arms: 2@ OPAR-6
35	34	181	4.9	8.5	18	75	3.2*	2.3	1.4	--	11.5	AHW35-26	Arms: 2@ OPAR-6

ALL POLES LISTED ON THIS PAGE HAVE BEEN ACCEPTED

PER THE 1985 AASHTO BREAKAWAY SPECIFICATIONS BY THE FEDERAL HIGHWAY ADMINISTRATION

■ Standard handhole: 2½" x 5" oval. Handhole covers are polyurethane coated to match pole color. ■ All poles are individually wrapped for shipment. ■ Poles on this page are predrilled for Shakespeare 6' Mast Arms. ■ Aluminum cap standard. ■ EPA and weight specifications include the arm(s). All EPA recommendations are based on poles with handholes, and in accordance with the AASHTO standard, include a 30% gust factor.

*Poles are not rated above 3.2 EPA because the mast arms are not rated for luminaires greater than 3.2 EPA each.

Breakaway 6' Mast Arm Composite Tuff-Poles®

AHW and ASW Series Anchor Base
Four Shakespeare 6-foot Mast Arms

**COMPOSITE
TUFF-POLE**

Nominal Mounting Height (ft.)	Shaft Length (ft.)	Pole Weight (lbs.)	POLE DIAMETER		Standard Handhole Location from Base (in.)	SUGGESTED MAXIMUM TOTAL LOADING PER ARM				Bolt Hole Circle (in.)	BASIC CATALOG NUMBER	Comment	
			Shaft Top (in.)	Shaft Base (in.)		Total Weight (lbs.)	80 MPH EPA* (sq. ft.)	90 MPH EPA* (sq. ft.)	100 MPH EPA* (sq. ft.)				120 MPH EPA* (sq. ft.)
BREAKAWAY Round Tapered Anchor Base pole with FOUR 6-foot Mast Arms @ 90°													
27	26	135	4.7	8.2	18	75	3.2*	3.0	2.2	1.0	11.5	ASW27-46	Arms: 4@ OPAR-6
27	26	167	4.9	8.3	18	75	3.2*	3.2*	3.2*	1.9	11.5	AHW27-46	Arms: 4@ OPAR-6
28	27	138	4.7	8.3	18	75	3.2*	2.9	2.0	0.9	11.5	ASW28-46	Arms: 4@ OPAR-6
28	27	171	4.9	8.4	18	75	3.2*	3.2*	3.2*	1.8	11.5	AHW28-46	Arms: 4@ OPAR-6
29	28	143	4.7	8.4	18	75	3.2*	2.7	1.8	0.8	11.5	ASW29-46	Arms: 4@ OPAR-6
29	28	176	4.9	8.5	18	75	3.2*	3.2*	3.1	1.6	11.5	AHW29-46	Arms: 4@ OPAR-6
30	29	146	4.7	8.4	18	75	3.2*	2.4	1.6	0.6	11.5	ASW30-46	Arms: 4@ OPAR-6
30	29	180	4.9	8.5	18	75	3.2*	3.2*	2.8	1.4	11.5	AHW30-46	Arms: 4@ OPAR-6
31	30	149	4.7	8.4	18	75	2.9	2.0	1.3	0.4	11.5	ASW31-46	Arms: 4@ OPAR-6
31	30	184	4.9	8.5	18	75	3.2*	3.2*	2.4	1.1	11.5	AHW31-46	Arms: 4@ OPAR-6
32	31	154	4.7	8.4	18	75	2.6	1.7	1.0	--	11.5	ASW32-46	Arms: 4@ OPAR-6
32	31	189	4.9	8.5	18	75	3.2*	2.9	2.0	0.9	11.5	AHW32-46	Arms: 4@ OPAR-6
33	32	157	4.7	8.4	18	75	2.3	1.5	0.9	--	11.5	ASW33-46	Arms: 4@ OPAR-6
33	32	193	4.9	8.5	18	75	3.2*	2.7	1.8	0.7	11.5	AHW33-46	Arms: 4@ OPAR-6
34	33	162	4.4	8.4	18	75	2.1	1.3	0.7	--	11.5	ASW34-46	Arms: 4@ OPAR-6
34	33	197	4.9	8.5	18	75	3.2*	2.5	1.7	0.6	11.5	AHW34-46	Arms: 4@ OPAR-6
35	34	159	4.7	8.4	18	75	1.4	0.7	--	--	11.5	ASW35-46	Arms: 4@ OPAR-6
35	34	201	4.9	8.5	18	75	3.2*	1.9	1.9	--	11.5	AHW35-46	Arms: 4@ OPAR-6

**ALL POLES LISTED ON THIS PAGE HAVE BEEN ACCEPTED
PER THE 1985 AASHTO BREAKAWAY SPECIFICATIONS BY THE FEDERAL HIGHWAY ADMINISTRATION**

For EPA specifications for Breakaway poles without arms, see Breakaway Round Tapered Poles.

■ Standard handhole: 2½" x 5" oval. Optional 4" x 6" or 4" x 12" handholes, depending on pole dimensions. For other handhole options, contact factory. All handhole covers are polyurethane coated to match pole color. ■ All poles are individually wrapped for shipment. ■ Poles on this page are predrilled for Shakespeare 6' Mast Arms. ■ Aluminum cap and wiring access hole standard.

■ EPA and weight specifications include the arm(s). All EPA recommendations are based on poles with handholes, and include a 30% gust factor.

*Poles are not rated above 3.2 EPA because the mast arms are not rated for luminaires greater than 3.2 EPA each.

Breakaway 6' Mast Arm Composite Tuff-Poles®

BAW, BBW, BCW, BHW, BSW and BXW Series Direct Burial Base

One, Two, or Four Shakespeare 6-foot Mast Arms



Nominal Mounting Height (ft.)	Shaft Length (ft.)	Pole Weight (lbs.)	POLE DIAMETER		Standard Handhole Location from Base (in.)	SUGGESTED MAXIMUM TOTAL LOADING PER ARM					Suggested Burial Depth (ft.)	BASIC CATALOG NUMBER	Comment
			Shaft Top (in.)	Shaft Base (in.)		Total Weight (lbs.)	80 MPH EPA* (sq. ft.)	90 MPH EPA* (sq. ft.)	100 MPH EPA* (sq. ft.)	120 MPH EPA* (sq. ft.)			
BREAKAWAY Round Tapered Direct Burial Base pole with ONE 6-foot Mast Arm													
20	23	68	4.6	7.3	66	75	3.2*	3.2*	3.2*	3.2*	4	BHW24-16	Arm: OPAR-6
25	29	81	4.5	8.2	78	75	3.2*	3.2*	2.4	0.9	5	BSW30-16	Arm: OPAR-6
25	29	108	4.7	8.3	78	75	3.2*	3.2*	3.2*	3.2*	5	BHW30-16	Arm: OPAR-6
30	34	92	4.5	8.3	78	75	2.6	1.5	0.7	--	5	BSW35-16	Arm: OPAR-6
30	34	126	4.7	8.4	78	75	3.2*	3.2*	3.2*	3.2*	5	BHW35-16	Arm: OPAR-6
35	40	159	6.2	11.6	90	75	3.2*	3.2*	3.2*	3.2*	6	BAW41-16	Arm: OPAR-6x6
40	46	182	6.2	11.7	102	75	3.2*	3.2*	1.8	1.8	7	BAW47-16	Arm: OPAR-6x6
40	46	253	6.4	11.8	102	75	3.2*	3.2*	3.2*	3.2*	7	BBW47-16	Arm: OPAR-6x6
BREAKAWAY Round Tapered Direct Burial Base pole with TWO 6-foot Mast Arms @ 180°													
25	29	91	4.5	8.2	78	75	1.6	0.8	--	--	5	BSW30-26	Arms: 2@ OPAR-6
25	29	118	4.7	8.3	78	75	3.2*	3.2*	3.2*	1.5	5	BHW30-26	Arms: 2@ OPAR-6
30	34	136	4.7	8.4	78	75	3.2*	2.9	1.9	0.8	5	BHW35-26	Arms: 2@ OPAR-6
30	34	173	4.9	8.5	78	75	3.2*	3.2*	3.2*	1.8	5	BXW35-26	Arms: 2@ OPAR-6
35	40	169	6.2	11.6	90	75	2.8	0.7	0.7	--	6	BAW41-26	Arms: 2@ OPAR-6x6
35	40	531	6.4	11.7	90	75	3.2*	3.2*	2.6	0.6	6	BBW41-26	Arms: 2@ OPAR-6x6
35	40	268	6.6	11.8	90	75	3.2*	3.2*	3.2*	2.2	6	BCW41-26	Arms: 2@ OPAR-6x6
40	46	192	6.2	11.7	102	75	2.0	1.0	--	--	7	BAW47-26	Arms: 2@ OPAR-6x6
40	46	263	6.4	11.8	102	75	3.2*	3.1	1.7	--	7	BBW47-26	Arms: 2@ OPAR-6x6
40	46	305	6.6	11.9	102	75	3.2*	3.2*	3.2*	1.4	7	BCW47-26	Arms: 2@ OPAR-6x6
BREAKAWAY Round Tapered Direct Burial Base pole with FOUR 6-foot Mast Arms @90°													
25	29	111	4.5	8.2	78	75	1.1	0.5	--	--	5	BSW30-46	Arms: 4@ OPAR-6
25	29	138	4.7	8.3	78	75	3.2*	3.1	2.2	1.2	5	BHW30-46	Arms: 4@ OPAR-6
25	29	172	4.9	8.5	78	75	3.2*	3.2*	3.2*	2.2	5	BXW30-46	Arms: 4@ OPAR-6
30	34	166	6.2	10.8	78	75	3.2*	2.3	1.5	0.4	5	BAW35-46	Arms: 4@ OPAR-6x6
30	34	219	6.4	10.9	78	75	3.2*	3.2*	3.1	1.7	5	BBW35-46	Arms: 4@ OPAR-6x6
35	40	189	6.2	11.6	90	75	1.9	1.1	0.5	--	6	BAW41-46	Arms: 4@ OPAR-6x6
35	40	251	6.4	11.7	90	75	3.2*	2.7	1.7	0.4	6	BBW41-46	Arms: 4@ OPAR-6x6
35	40	288	6.6	11.8	90	75	3.2*	3.2*	3.2*	1.8	6	BCW41-46	Arms: 4@ OPAR-6x6
40	46	283	6.4	11.8	102	75	3.2*	2.1	1.1	--	7	BBW47-46	Arms: 4@ OPAR-6x6
40	46	325	6.6	11.9	102	75	3.2*	3.2*	2.6	1.1	7	BCW47-46	Arms: 4@ OPAR-6x6

For EPA specifications for Breakaway poles without arms, see Breakaway Round Tapered Poles.

**ALL POLES LISTED ON THIS PAGE HAVE BEEN ACCEPTED
PER THE 1985 AASHTO BREAKAWAY SPECIFICATIONS BY THE FEDERAL HIGHWAY ADMINISTRATION**

■ Standard handhole: 2½" x 5" oval. Optional 4" x 6" or 4" x 12" handholes, depending on pole dimensions. For other handhole options, contact factory. All handhole covers are polyurethane coated to match pole color. ■ All poles are individually wrapped for shipment. ■ Poles on this page are predrilled for Shakespeare 6' Mast Arms. ■ Aluminum cap and wiring access hole standard. ■ EPA and weight specifications include the arm(s). All EPA recommendations are based on poles with handholes, and include a 30% gust factor.

*Poles are not rated above 3.2 EPA because the mast arms are not rated for luminaires greater than 3.2 EPA each.

Breakaway 8' Mast Arm Composite Tuff-Poles®

AHW and ASW Series Anchor Base
One or Two Shakespeare 8-foot Mast Arms



Nominal Mounting Height (ft.)	Shaft Length (ft.)	Pole Weight (lbs.)	POLE DIAMETER		Standard Handhole Location from Base (in.)	SUGGESTED MAXIMUM TOTAL LOADING PER ARM					Bolt Hole Circle (in.)	BASIC CATALOG NUMBER	Comment
			Shaft Top (in.)	Shaft Base (in.)		Total Weight (lbs.)	80 MPH EPA* (sq. ft.)	90 MPH EPA* (sq. ft.)	100 MPH EPA* (sq. ft.)	120 MPH EPA* (sq. ft.)			
BREAKAWAY Round Tapered Anchor Base pole with ONE 8-foot Mast Arm													
27	25	110	4.7	8.0	18	75	3.2*	3.2*	3.2*	3.2*	11.5	ASW27-18	Arm: OPAR-8
27	25	139	4.9	8.2	18	75	3.2*	3.2*	3.2*	3.2*	11.5	AHW27-18	Arm: OPAR-8
28	26	115	4.7	8.2	18	75	3.2*	3.2*	3.2*	3.2*	11.5	ASW28-18	Arm: OPAR-8
28	26	142	4.9	8.3	18	75	3.2*	3.2*	3.2*	3.2*	11.5	AHW28-18	Arm: OPAR-8
29	27	118	4.7	8.3	18	75	3.2*	3.2*	3.2*	3.1	11.5	ASW29-18	Arm: OPAR-8
29	27	147	4.9	8.4	18	75	3.2*	3.2*	3.2*	3.2*	11.5	AHW29-18	Arm: OPAR-8
30	28	122	4.7	8.3	18	75	3.2*	3.2*	3.2*	2.7	11.5	ASW30-18	Arm: OPAR-8
30	28	151	4.9	8.5	18	75	3.2*	3.2*	3.2*	3.2*	11.5	AHW30-18	Arm: OPAR-8
31	29	126	4.7	8.4	18	75	3.2*	3.2*	3.2*	2.1	11.5	ASW31-18	Arm: OPAR-8
31	29	155	4.9	8.5	18	75	3.2*	3.2*	3.2*	3.2*	11.5	AHW31-18	Arm: OPAR-8
32	30	129	4.7	8.4	18	75	3.2*	3.2*	3.2*	1.6	11.5	ASW32-18	Arm: OPAR-8
32	30	160	4.9	8.5	18	75	3.2*	3.2*	3.2*	3.2*	11.5	AHW32-18	Arm: OPAR-8
33	31	134	4.7	8.4	18	75	3.2*	3.2*	3.2*	1.3	11.5	ASW33-18	Arm: OPAR-8
33	31	164	4.9	8.5	18	75	3.2*	3.2*	3.2*	3.0	11.5	AHW33-18	Arm: OPAR-8
34	32	137	4.4	8.4	18	75	3.2*	3.2*	3.0	1.0	11.5	ASW34-18	Arm: OPAR-8
34	32	168	4.9	8.5	18	75	3.2*	3.2*	3.2*	2.7	11.5	AHW34-18	Arm: OPAR-8
35	33	136	4.7	8.4	18	75	3.2*	3.2*	2.6	0.8	11.5	ASW35-18	Arm: OPAR-8
35	33	171	4.9	8.5	18	75	3.2*	3.2*	3.2*	2.3	11.5	AHW35-18	Arm: OPAR-8
BREAKAWAY Round Tapered Anchor Base pole with TWO 8-foot Mast Arms @180°													
27	25	123	4.7	8.0	18	75	3.2*	3.1	2.0	0.6	11.5	ASW27-28	Arms: 2@ OPAR-8
27	25	152	4.9	8.2	18	75	3.2*	3.2*	3.2*	1.7	11.5	AHW27-28	Arms: 2@ OPAR-8
28	26	128	4.7	8.2	18	75	3.2*	2.9	1.8	0.4	11.5	ASW28-28	Arms: 2@ OPAR-8
28	26	155	4.9	8.3	18	75	3.2*	3.2*	3.2*	1.5	11.5	AHW28-28	Arms: 2@ OPAR-8
29	27	131	4.7	8.3	18	75	3.2*	2.7	1.7	--	11.5	ASW29-28	Arms: 2@ OPAR-8
29	27	160	4.9	8.4	18	75	3.2*	3.2*	3.2*	1.3	11.5	AHW29-28	Arms: 2@ OPAR-8
30	28	135	4.7	8.3	18	75	3.2*	2.4	1.4	--	11.5	ASW30-28	Arms: 2@ OPAR-8
30	28	164	4.9	8.5	18	75	3.2*	3.2*	2.9	1.1	11.5	AHW30-28	Arms: 2@ OPAR-8
31	29	139	4.7	8.4	18	75	3.1	1.9	1.0	--	11.5	ASW31-28	Arms: 2@ OPAR-8
31	29	168	4.9	8.5	18	75	3.2*	3.2*	2.4	0.8	11.5	AHW31-28	Arms: 2@ OPAR-8
32	30	142	4.7	8.4	18	75	2.6	1.4	0.6	--	11.5	ASW32-28	Arms: 2@ OPAR-8
32	30	173	4.9	8.5	18	75	3.2*	3.0	1.9	0.4	11.5	AHW32-28	Arms: 2@ OPAR-8
33	31	147	4.7	8.4	18	75	2.3	1.2	0.4	--	11.5	ASW33-28	Arms: 2@ OPAR-8
33	31	177	4.9	8.5	18	75	3.2*	2.7	1.7	--	11.5	AHW33-28	Arms: 2@ OPAR-8
34	32	150	4.4	8.4	18	75	2.0	0.9	--	--	11.5	ASW34-28	Arms: 2@ OPAR-8
34	32	181	4.9	8.5	18	75	3.2*	2.4	1.4	--	11.5	AHW34-28	Arms: 2@ OPAR-8
35	33	149	4.7	8.4	18	75	1.7	0.7	--	--	11.5	ASW35-28	Arms: 2@ OPAR-8
35	33	184	4.9	8.5	18	75	3.2*	2.2	1.2	--	11.5	AHW35-28	Arms: 2@ OPAR-8

ALL POLES LISTED ON THIS PAGE HAVE BEEN ACCEPTED

PER THE 1985 AASHTO BREAKAWAY SPECIFICATIONS BY THE FEDERAL HIGHWAY ADMINISTRATION

■ Standard handhole: 2½" x 5" oval. Handhole covers are polyurethane coated to match pole color. ■ All poles are individually wrapped for shipment. ■ Poles on this page are predrilled for Shakespeare 8' Mast Arms. ■ Aluminum cap standard.

*Poles are not rated above 3.2 EPA because the mast arms are not rated for luminaires greater than 3.2 EPA each. EPA and weight specifications include the arm(s). All EPA recommendations are based on poles with handholes, and include a 30% gust factor.

Breakaway 8' Mast Arm Composite Tuff-Poles®

AHW and ASW Series Anchor Base

Four Shakespeare 8-foot Mast Arms



Nominal Mounting Height (ft.)	Shaft Length (ft.)	Pole Weight (lbs.)	POLE DIAMETER		Standard Handhole Location from Base (in.)	SUGGESTED MAXIMUM TOTAL LOADING PER ARM				Bolt Hole Circle (in.)	BASIC CATALOG NUMBER	Comment	
			Shaft Top (in.)	Shaft Base (in.)		Total Weight (lbs.)	80 MPH EPA* (sq. ft.)	90 MPH EPA* (sq. ft.)	100 MPH EPA* (sq. ft.)				120 MPH EPA* (sq. ft.)
BREAKAWAY Round Tapered Anchor Base pole with FOUR 8-foot Mast Arms @90°													
27	25	136	4.7	8.0	18	75	3.2*	2.5	1.6	0.5	11.5	ASW27-48	Arms: 4@ OPAR-8
27	25	165	4.9	8.2	18	75	3.2*	3.2*	2.9	1.4	11.5	AHW27-48	Arms: 4@ OPAR-8
28	26	141	4.7	8.2	18	75	3.2*	2.3	1.5	--	11.5	ASW28-48	Arms: 4@ OPAR-8
28	26	168	4.9	8.3	18	75	3.2*	3.2*	2.7	1.2	11.5	AHW28-48	Arms: 4@ OPAR-8
29	27	144	4.7	8.3	18	75	3.2*	2.2	1.3	--	11.5	ASW29-48	Arms: 4@ OPAR-8
29	27	173	4.9	8.4	18	75	3.2*	3.2*	2.6	1.0	11.5	AHW29-48	Arms: 4@ OPAR-8
30	28	148	4.7	8.3	18	75	3.0	1.9	1.1	--	11.5	ASW30-48	Arms: 4@ OPAR-8
30	28	177	4.9	8.5	18	75	3.2*	3.2*	2.3	0.9	11.5	AHW30-48	Arms: 4@ OPAR-8
31	29	152	4.7	8.4	18	75	2.5	1.5	0.8	--	11.5	ASW31-48	Arms: 4@ OPAR-8
31	29	181	4.9	8.5	18	75	3.2*	2.8	1.9	0.6	11.5	AHW31-48	Arms: 4@ OPAR-8
32	30	155	4.7	8.4	18	75	2.1	1.2	0.5	--	11.5	ASW32-48	Arms: 4@ OPAR-8
32	30	186	4.9	8.5	18	75	3.2*	2.4	1.5	--	11.5	AHW32-48	Arms: 4@ OPAR-8
33	31	160	4.7	8.4	18	75	1.8	0.9	--	--	11.5	ASW33-48	Arms: 4@ OPAR-8
33	31	190	4.9	8.5	18	75	3.2*	2.2	1.3	--	11.5	AHW33-48	Arms: 4@ OPAR-8
34	32	163	4.4	8.4	18	75	1.6	0.8	--	--	11.5	ASW34-48	Arms: 4@ OPAR-8
34	32	194	4.9	8.5	18	75	3.1	1.9	1.1	--	11.5	AHW34-48	Arms: 4@ OPAR-8
35	33	162	4.7	8.4	18	75	1.4	0.6	--	--	11.5	ASW35-48	Arms: 4@ OPAR-8
35	33	197	4.9	8.5	18	75	2.8	1.7	1.0	--	11.5	AHW35-48	Arms: 4@ OPAR-8

**ALL POLES LISTED ON THIS PAGE HAVE BEEN ACCEPTED
PER THE 1985 AASHTO BREAKAWAY SPECIFICATIONS BY THE FEDERAL HIGHWAY ADMINISTRATION**

■ Standard handhole: 2½" x 5" oval. Handhole covers are polyurethane coated to match pole color. ■ All poles are individually wrapped for shipment. ■ Poles on this page are predrilled for Shakespeare 8' Mast Arms. ■ Aluminum cap standard.

*Poles are not rated above 3.2 EPA because the mast arms are not rated for luminaires greater than 3.2 EPA each. EPA and weight specifications include the arm(s). All EPA recommendations are based on poles with handholes, and include a 30% gust factor.

Breakaway 8' Mast Arm Composite Tuff-Poles®

BAW, BBW, BCW, BHW, BSW and BXW Series Direct Burial Base

One, Two, or Four Shakespeare 8-foot Mast Arms

**COMPOSITE
TUFF-POLE**

Nominal Mounting Height (ft.)	Shaft Length (ft.)	Pole Weight (lbs.)	POLE DIAMETER		Standard Handhole Location from Base (in.)	SUGGESTED MAXIMUM TOTAL LOADING PER ARM					Suggested Burial Depth (ft.)	BASIC CATALOG NUMBER	Comment
			Shaft Top (in.)	Shaft Base (in.)		Total Weight (lbs.)	80 MPH EPA* (sq. ft.)	90 MPH EPA* (sq. ft.)	100 MPH EPA* (sq. ft.)	120 MPH EPA* (sq. ft.)			
BREAKAWAY Round Tapered Direct Burial Base pole with ONE 8-foot Mast Arm													
20	22	70	4.6	7.3	66	75	3.2*	3.2*	3.2*	3.0	4	BHW24-18	Arm: OPAR-8
25	28	81	4.5	8.2	78	75	3.2*	3.2*	1.8	--	5	BSW30-18	Arm: OPAR-8
25	28	108	4.7	8.3	78	75	3.2*	3.2*	3.2*	3.2*	5	BHW30-18	Arm: OPAR-8
30	33	92	4.5	8.3	78	75	2.1	0.9	--	--	5	BSW35-18	Arm: OPAR-8
30	33	125	4.7	8.4	78	75	3.2*	3.2*	3.2*	2.7	5	BHW35-18	Arm: OPAR-8
35	39	160	6.2	11.5	90	75	3.2*	3.2*	2.7	--	6	BAW41-18	Arm: OPAR-8x6
35	39	222	6.4	11.6	90	75	3.2*	3.2*	3.2*	2.4	6	BBW41-18	Arm: OPAR-8x6
40	45	183	6.2	11.7	102	75	3.2*	3.2*	1.2	--	7	BAW47-18	Arm: OPAR-8x6
40	45	253	6.4	11.8	102	75	3.2*	3.2*	3.2*	1.0	7	BBW47-18	Arm: OPAR-8x6
BREAKAWAY Round Tapered Direct Burial Base pole with TWO 8-foot Mast Arms @ 180°													
25	28	122	4.7	8.3	78	75	3.2*	3.2*	2.7	0.8	5	BHW30-28	Arms: 2@ OPAR-8
25	28	154	4.9	8.5	78	75	3.2*	3.2*	3.2*	2.0	5	BXW30-28	Arms: 2@ OPAR-8
30	33	139	4.7	8.4	78	75	3.2*	2.2	1.3	--	5	BHW35-28	Arms: 2@ OPAR-8
30	33	176	4.9	8.5	78	75	3.2*	3.2*	2.8	1.1	5	BXW35-28	Arms: 2@ OPAR-8
30	33	203	6.4	10.7	78	75	3.2*	3.2*	3.2*	1.5	5	BBW35-28	Arms: 2@ OPAR-8x6
35	39	236	6.4	11.6	90	75	3.2*	3.2*	1.9	--	6	BBW41-28	Arms: 2@ OPAR-8x6
35	39	271	6.6	11.7	90	75	3.2*	3.2*	3.2*	1.5	6	BCW41-28	Arms: 2@ OPAR-8x6
40	45	267	6.4	11.8	102	75	3.2*	2.4	1.0	--	7	BBW47-28	Arms: 2@ OPAR-8x6
40	45	310	6.6	11.9	102	75	3.2*	3.2*	3.2*	0.7	7	BCW47-28	Arms: 2@ OPAR-8x6
BREAKAWAY Round Tapered Direct Burial Base pole with FOUR 8-foot Mast Arms @90°													
25	28	150	4.7	8.3	78	75	3.2*	2.6	1.8	0.6	5	BHW30-48	Arms: 4@ OPAR-8
25	28	182	4.9	8.5	78	75	3.2*	3.2*	3.0	1.6	5	BXW30-48	Arms: 4@ OPAR-8
30	33	167	4.7	8.4	78	75	2.4	1.5	0.9	--	5	BHW35-48	Arms: 4@ OPAR-8
30	33	204	4.9	8.5	78	75	3.2*	2.7	1.9	0.9	5	BXW35-48	Arms: 4@ OPAR-8
30	33	262	6.6	10.9	78	75	3.2*	3.2*	3.2	2.8	5	BCW35-48	Arms: 4@ OPAR-8x6
35	39	264	6.4	11.6	90	75	3.2*	2.3	1.3	--	6	BBW41-48	Arms: 4@ OPAR-8x6
35	39	299	6.6	11.7	90	75	3.2*	3.2*	2.9	1.2	6	BCW41-48	Arms: 4@ OPAR-8x6
40	45	295	6.4	11.8	102	75	2.8	1.6	0.7	--	7	BBW47-48	Arms: 4@ OPAR-8x6
40	45	338	6.6	11.9	102	75	3.2*	3.2*	2.1	0.5	7	BCW47-48	Arms: 4@ OPAR-8x6

For EPA specifications for Breakaway poles without arms, see Breakaway Round Tapered Poles.

**ALL POLES LISTED ON THIS PAGE HAVE BEEN ACCEPTED
PER THE 1985 AASHTO BREAKAWAY SPECIFICATIONS BY THE FEDERAL HIGHWAY ADMINISTRATION**

■ Standard handhole: 2½" x 5" oval. Optional 4" x 6" or 4" x 12" handholes, depending on pole dimensions. For other handhole options, contact factory. All handhole covers are polyurethane coated to match pole color. ■ All poles are individually wrapped for shipment. ■ Poles on this page are predrilled for Shakespeare 8' Mast Arms. ■ Aluminum cap and wiring access hole standard. ■ EPA and weight specifications include the arm(s). All EPA recommendations are based on poles with handholes, and include a 30% gust factor.

*Poles are not rated above 3.2 EPA because the mast arms are not rated for luminaires greater than 3.2 EPA each.

Breakaway 10' Mast Arm Composite Tuff-Poles®

AHW and ASW Series Anchor Base

One or Two Shakespeare 10-foot Mast Arms



Nominal Mounting Height (ft.)	Shaft Length (ft.)	Pole Weight (lbs.)	POLE DIAMETER		Standard Handhole Location from Base (in.)	SUGGESTED MAXIMUM TOTAL LOADING PER ARM				Bolt Hole Circle (in.)	BASIC CATALOG NUMBER	Comment	
			Shaft Top (in.)	Shaft Base (in.)		Total Weight (lbs.)	80 MPH EPA* (sq. ft.)	90 MPH EPA* (sq. ft.)	100 MPH EPA* (sq. ft.)				120 MPH EPA* (sq. ft.)
BREAKAWAY Round Tapered Anchor Base pole with ONE 10-foot Mast Arm													
27	24.5	107	4.7	8.0	18	75	3.2*	3.2*	3.2*	2.8	11.5	ASW27-11	Arm: OPAR-10
27	24.5	138	4.9	8.1	18	75	3.2*	3.2*	3.2*	3.2*	11.5	AHW27-11	Arm: OPAR-10
28	25.5	111	4.7	8.1	18	75	3.2*	3.2*	3.2*	2.5	11.5	ASW28-11	Arm: OPAR-10
28	25.5	142	4.9	8.2	18	75	3.2*	3.2*	3.2*	3.2*	11.5	AHW28-11	Arm: OPAR-10
29	26.5	115	4.7	8.2	18	75	3.2*	3.2*	3.2*	2.3	11.5	ASW29-11	Arm: OPAR-10
29	26.5	147	4.9	8.3	18	75	3.2*	3.2*	3.2*	3.2*	11.5	AHW29-11	Arm: OPAR-10
30	27.5	118	4.7	8.3	18	75	3.2*	3.2*	3.2*	2.0	11.5	ASW30-11	Arm: OPAR-10
30	27.5	151	4.9	8.4	18	75	3.2*	3.2*	3.2*	3.2*	11.5	AHW30-11	Arm: OPAR-10
31	28.5	121	4.7	8.3	18	75	3.2*	3.2*	3.2*	1.5	11.5	ASW31-11	Arm: OPAR-10
31	28.5	155	4.9	8.5	18	75	3.2*	3.2*	3.2*	3.2*	11.5	AHW31-11	Arm: OPAR-10
32	29.5	125	4.7	8.4	18	75	3.2*	3.2*	3.1	0.9	11.5	ASW32-11	Arm: OPAR-10
32	29.5	160	4.9	8.5	18	75	3.2*	3.2*	3.2*	2.6	11.5	AHW32-11	Arm: OPAR-10
33	30.5	128	4.7	8.4	18	75	3.2*	3.2*	2.7	0.6	11.5	ASW33-11	Arm: OPAR-10
33	30.5	164	4.9	8.5	18	75	3.2*	3.2*	3.2*	2.3	11.5	AHW33-11	Arm: OPAR-10
34	31.5	133	4.4	8.4	18	75	3.2*	3.2*	2.3	--	11.5	ASW34-11	Arm: OPAR-10
34	31.5	164	4.9	8.5	18	75	3.2*	3.2*	3.2*	1.9	11.5	AHW34-11	Arm: OPAR-10
35	32.5	136	4.7	8.4	18	75	3.2*	3.2*	1.9	--	11.5	ASW35-11	Arm: OPAR-10
35	32.5	172	4.9	8.5	18	75	3.2*	3.2*	3.2*	1.6	11.5	AHW35-11	Arm: OPAR-10
BREAKAWAY Round Tapered Anchor Base pole with TWO 10-foot Mast Arms @180°													
27	24.5	124	4.7	8.0	18	75	3.2*	2.3	1.2	--	11.5	ASW27-21	Arms: 2@ OPAR-10
27	24.5	155	4.9	8.1	18	75	3.2*	3.2*	2.8	0.9	11.5	AHW27-21	Arms: 2@ OPAR-10
28	25.5	128	4.7	8.1	18	75	3.2*	2.1	1.0	--	11.5	ASW28-21	Arms: 2@ OPAR-10
28	25.5	159	4.9	8.2	18	75	3.2*	3.2*	2.6	0.7	11.5	AHW28-21	Arms: 2@ OPAR-10
29	26.5	132	4.7	8.2	18	75	3.2*	1.9	0.8	--	11.5	ASW29-21	Arms: 2@ OPAR-10
29	26.5	164	4.9	8.3	18	75	3.2*	3.2*	2.4	0.5	11.5	AHW29-21	Arms: 2@ OPAR-10
30	27.5	135	4.7	8.3	18	75	3.1	1.6	0.6	--	11.5	ASW30-21	Arms: 2@ OPAR-10
30	27.5	168	4.9	8.4	18	75	3.2*	3.2*	2.1	0.4	11.5	AHW30-21	Arms: 2@ OPAR-10
31	28.5	138	4.7	8.3	18	75	2.4	1.2	0.4	--	11.5	ASW31-21	Arms: 2@ OPAR-10
31	28.5	172	4.9	8.5	18	75	3.2*	2.9	1.7	--	11.5	AHW31-21	Arms: 2@ OPAR-10
32	29.5	142	4.7	8.4	18	75	1.8	0.7	--	--	11.5	ASW32-21	Arms: 2@ OPAR-10
32	29.5	177	4.9	8.5	18	75	3.2*	2.3	1.1	--	11.5	AHW32-21	Arms: 2@ OPAR-10
33	30.5	145	4.7	8.4	18	75	1.5	0.4	--	--	11.5	ASW33-21	Arms: 2@ OPAR-10
33	30.5	181	4.9	8.5	18	75	3.2*	2.0	0.9	--	11.5	AHW33-21	Arms: 2@ OPAR-10
34	31.5	150	4.4	8.4	18	75	1.2	--	--	--	11.5	ASW34-21	Arms: 2@ OPAR-10
34	31.5	185	4.9	8.5	18	75	3.1	1.7	0.7	--	11.5	AHW34-21	Arms: 2@ OPAR-10
35	32.5	189	4.9	8.5	18	75	2.8	0.4	0.4	--	11.5	AHW35-21	Arms: 2@ OPAR-10

ALL POLES LISTED ON THIS PAGE HAVE BEEN ACCEPTED

PER THE 1985 AASHTO BREAKAWAY SPECIFICATIONS BY THE FEDERAL HIGHWAY ADMINISTRATION

■ Standard handhole: 2½" x 5" oval. Handhole covers are polyurethane coated to match pole color. ■ All poles are individually wrapped for shipment. ■ Poles on this page are predrilled for Shakespeare 10' Mast Arms. ■ Aluminum cap standard.

*Poles are not rated above 3.2 EPA because the mast arms are not rated for luminaires greater than 3.2 EPA each. EPA and weight specifications include the arm(s). All EPA recommendations are based on poles with handholes, and include a 30% gust factor.

Breakaway 10' Mast Arm Composite Tuff-Poles®

AHW and ASW Series Anchor Base
Four Shakespeare 10-foot Mast Arms

**COMPOSITE
TUFF-POLE®**

Nominal Mounting Height (ft.)	Shaft Length (ft.)	Pole Weight (lbs.)	POLE DIAMETER		Standard Handhole Location from Base (in.)	SUGGESTED MAXIMUM TOTAL LOADING PER ARM					Bolt Hole Circle (in.)	BASIC CATALOG NUMBER	Comment
			Shaft Top (in.)	Shaft Base (in.)		Total Weight (lbs.)	80 MPH EPA* (sq. ft.)	90 MPH EPA* (sq. ft.)	100 MPH EPA* (sq. ft.)	120 MPH EPA* (sq. ft.)			
BREAKAWAY Round Tapered Anchor Base pole with FOUR 10-foot Mast Arms @90°													
27	24.5	158	4.7	8.0	18	75	3.1	1.8	0.9	--	11.5	ASW27-41	Arms: 4@ OPAR-10
27	24.5	189	4.9	8.1	18	75	3.2*	3.2*	2.2	0.7	11.5	AHW27-41	Arms: 4@ OPAR-10
28	25.5	162	4.7	8.1	18	75	2.9	1.7	0.8	--	11.5	ASW28-41	Arms: 4@ OPAR-10
28	25.5	193	4.9	8.2	18	75	3.2*	3.2*	2.1	0.6	11.5	AHW28-41	Arms: 4@ OPAR-10
29	26.5	166	4.7	8.2	18	75	2.7	1.5	0.7	--	11.5	ASW29-41	Arms: 4@ OPAR-10
29	26.5	198	4.9	8.3	18	75	3.2*	3.0	1.9	0.4	11.5	AHW29-41	Arms: 4@ OPAR-10
30	27.5	169	4.7	8.3	18	75	2.4	1.3	0.5	--	11.5	ASW30-41	Arms: 4@ OPAR-10
30	27.5	202	4.9	8.4	18	75	3.2*	2.8	1.7	--	11.5	AHW30-41	Arms: 4@ OPAR-10
31	28.5	172	4.7	8.3	18	75	2.0	1.0	--	--	11.5	ASW31-41	Arms: 4@ OPAR-10
31	28.5	206	4.9	8.5	18	75	3.2*	2.3	1.3	--	11.5	AHW31-41	Arms: 4@ OPAR-10
32	29.5	176	4.7	8.4	18	75	1.5	0.5	--	--	11.5	ASW32-41	Arms: 4@ OPAR-10
32	29.5	211	4.9	8.5	18	75	3.1	1.8	0.9	--	11.5	AHW32-41	Arms: 4@ OPAR-10
33	30.5	179	4.7	8.4	18	75	1.2	--	--	--	11.5	ASW33-41	Arms: 4@ OPAR-10
33	20.5	215	4.9	8.5	18	75	2.8	1.6	0.7	--	11.5	AHW33-41	Arms: 4@ OPAR-10
34	31.5	219	4.4	8.4	18	75	2.5	1.4	--	--	11.5	AHW34-41	Arms: 4@ OPAR-10
35	32.5	223	4.9	8.5	18	75	1.1	1.1	--	--	11.5	AHW35-41	Arms: 4@ OPAR-10

**ALL POLES LISTED ON THIS PAGE HAVE BEEN ACCEPTED
PER THE 1985 AASHTO BREAKAWAY SPECIFICATIONS BY THE FEDERAL HIGHWAY ADMINISTRATION**

For EPA specifications for Breakaway poles without arms, see Breakaway Round Tapered Poles.

■ Standard handhole: 2½" x 5" oval. Handhole covers are polyurethane coated to match pole color. ■ All poles are individually wrapped for shipment. ■ Poles on this page are predrilled for Shakespeare 10' Mast Arms. ■ Aluminum cap standard.

*Poles are not rated above 3.2 EPA because the mast arms are not rated for luminaires greater than 3.2 EPA each. EPA and weight specifications include the arm(s). All EPA recommendations are based on poles with handholes, and include a 30% gust factor.

Breakaway 10' Mast Arm Composite Tuff-Poles®

BAW, BBW, BCW, BHW, BSW and BXW Series Direct Burial Base

One, Two, or Four Shakespeare 10-foot Mast Arms



Nominal Mounting Height (ft.)	Shaft Length (ft.)	Pole Weight (lbs.)	POLE DIAMETER		Standard Handhole Location from Base (in.)	SUGGESTED MAXIMUM TOTAL LOADING PER ARM					Suggested Burial Depth (ft.)	BASIC CATALOG NUMBER	Comment
			Shaft Top (in.)	Shaft Base (in.)		Total Weight (lbs.)	80 MPH EPA* (sq. ft.)	90 MPH EPA* (sq. ft.)	100 MPH EPA* (sq. ft.)	120 MPH EPA* (sq. ft.)			
BREAKAWAY Round Tapered Direct Burial Base pole with ONE 10-foot Mast Arm													
20	21.5	82	4.6	7.3	66	75	3.2*	3.2*	3.2*	2.3	4	BHW24-11	Arm: OPAR-10
25	27.5	84	4.5	8.2	78	75	3.2*	2.2	1.1	--	5	BSW30-11	Arm: OPAR-10
25	27.5	110	4.7	8.3	78	75	3.2*	3.2*	3.2*	3.2*	5	BHW30-11	Arm: OPAR-10
30	32.5	128	4.7	8.4	78	75	3.2*	3.2*	3.2*	2.0	5	BHW35-11	Arm: OPAR-10
35	38.5	161	6.2	11.4	90	75	3.2*	3.2*	2.7	--	6	BAW41-11	Arm: OPAR-10x6
35	38.5	196	6.4	11.5	90	75	3.2*	3.2*	3.2*	2.5	6	BBW41-11	Arm: OPAR-10x6
40	44.5	184	6.2	11.7	102	75	3.2*	2.4	0.5	--	7	BAW47-11	Arm: OPAR-10x6
40	44.5	254	6.4	11.8	102	75	3.2*	3.2*	3.2*	--	7	BBW47-11	Arm: OPAR-10x6
BREAKAWAY Round Tapered Direct Burial Base pole with TWO 10-foot Mast Arms @ 180°													
25	27.5	127	4.7	8.3	78	75	3.2*	3.2*	1.9	--	5	BHW30-21	Arms: 2@ OPAR-10
25	27.5	160	4.9	8.5	78	75	3.2*	3.2*	3.2*	1.2	5	BXW30-21	Arms: 2@ OPAR-10
30	32.5	145	4.7	8.4	78	75	2.8	1.5	0.5	--	5	BHW35-21	Arms: 2@ OPAR-10
30	32.5	181	4.9	8.5	78	75	3.2*	3.2*	2.0	0.4	5	BXW35-21	Arms: 2@ OPAR-10
30	32.5	206	6.4	10.6	78	75	3.2*	3.2*	3.0	0.7	5	BBW35-21	Arms: 2@ OPAR-10x6
35	38.5	259	6.4	11.5	90	75	3.2*	3.0	1.5	--	6	BBW41-21	Arms: 2@ OPAR-10x6
35	38.5	274	6.6	11.6	90	75	3.2*	3.2*	3.2*	1.2	6	BCW41-21	Arms: 2@ OPAR-10x6
40	44.5	271	6.4	11.8	102	75	3.2*	1.6	--	--	7	BBW47-21	Arms: 2@ OPAR-10x6
40	44.5	311	6.6	11.9	102	75	3.2*	3.2*	2.4	--	7	BCW47-21	Arms: 2@ OPAR-10x6
BREAKAWAY Round Tapered Direct Burial Base pole with FOUR 10-foot Mast Arms @90°													
25	27.5	161	4.7	8.3	78	75	3.2*	2.1	1.3	--	5	BHW30-41	Arms: 4@ OPAR-10
25	27.5	194	4.9	8.4	78	75	3.2*	3.2*	2.5	0.9	5	BXW30-41	Arms: 4@ OPAR-10
25	27.5	239	6.6	10.1	78	75	3.2*	3.2*	3.2*	3.0	5	BCW30-41	Arms: 4@ OPAR-10x6
30	32.5	215	4.9	8.5	78	75	3.2*	2.2	1.3	0.3	5	BXW35-41	Arms: 4@ OPAR-10
30	32.5	240	6.4	10.6	78	75	3.2*	3.1	2.0	0.5	5	BBW35-41	Arms: 4@ OPAR-10x6
30	32.5	270	6.6	10.8	78	75	3.2*	3.2*	3.2*	2.1	5	BCW35-41	Arms: 4@ OPAR-10x6
35	38.5	273	6.4	11.5	90	75	3.2*	2.0	1.0	--	6	BBW41-41	Arms: 4@ OPAR-10x6
35	38.5	308	6.6	11.6	90	75	3.2*	3.2*	2.6	0.9	6	BCW41-41	Arms: 4@ OPAR-10x6
40	44.5	305	6.4	11.8	102	75	3.2*	1.3	--	--	7	BBW47-41	Arms: 4@ OPAR-10x6
40	44.5	345	6.6	11.9	102	75	3.2*	2.9	1.6	--	7	BCW47-41	Arms: 4@ OPAR-10x6

For EPA specifications for Breakaway poles without arms, see Breakaway Round Tapered Poles.

**ALL POLES LISTED ON THIS PAGE HAVE BEEN ACCEPTED
PER THE 1985 AASHTO BREAKAWAY SPECIFICATIONS BY THE FEDERAL HIGHWAY ADMINISTRATION**

■ Standard handhole: 2½" x 5" oval. Optional 4" x 6" or 4" x 12" handholes, depending on pole dimensions. For other handhole options, contact factory. All handhole covers are polyurethane coated to match pole color. ■ All poles are individually wrapped for shipment. ■ Poles on this page are predrilled for Shakespeare 10' Mast Arms. ■ Aluminum cap and wiring access hole standard. ■ EPA and weight specifications include the arm(s). All EPA recommendations are based on poles with handholes, and include a 30% gust factor.

*Poles are not rated above 3.2 EPA because the mast arms are not rated for luminaires greater than 3.2 EPA each.

Breakaway 12' Mast Arm Composite Tuff-Poles®

AHW and ASW Series Anchor Base

One or Two Shakespeare 12-foot Mast Arms

**COMPOSITE
TUFF-POLE**

Nominal Mounting Height (ft.)	Shaft Length (ft.)	Pole Weight (lbs.)	POLE DIAMETER		Standard Handhole Location from Base (in.)	SUGGESTED MAXIMUM TOTAL LOADING PER ARM					Bolt Hole Circle (in.)	BASIC CATALOG NUMBER	Comment
			Shaft Top (in.)	Shaft Base (in.)		Total Weight (lbs.)	80 MPH EPA* (sq. ft.)	90 MPH EPA* (sq. ft.)	100 MPH EPA* (sq. ft.)	120 MPH EPA* (sq. ft.)			
BREAKAWAY Round Tapered Anchor Base pole with ONE 12-foot Mast Arm													
27	24	109	4.7	7.9	18	75	3.2*	3.2*	3.2*	2.2	11.5	ASW27-12	Arm: OPAR-12
27	24	140	4.9	8.0	18	75	3.2*	3.2*	3.2*	3.2*	11.5	AHW27-12	Arm: OPAR-12
28	25	112	4.7	8.0	18	75	3.2*	3.2*	3.2*	1.9	11.5	ASW28-12	Arm: OPAR-12
28	25	144	4.9	8.2	18	75	3.2*	3.2*	3.2*	3.2*	11.5	AHW28-12	Arm: OPAR-12
29	26	116	4.7	8.2	18	75	3.2*	3.2*	3.2*	1.7	11.5	ASW29-12	Arm: OPAR-12
29	26	148	4.9	8.3	18	75	3.2*	3.2*	3.2*	3.2*	11.5	AHW29-12	Arm: OPAR-12
30	27	119	4.7	8.3	18	75	3.2*	3.2*	3.2*	1.4	11.5	ASW30-12	Arm: OPAR-12
30	27	153	4.9	8.4	18	75	3.2*	3.2*	3.2*	3.2*	11.5	AHW30-12	Arm: OPAR-12
31	28	122	4.7	8.3	18	75	3.2*	3.2*	3.2*	1.0	11.5	ASW31-12	Arm: OPAR-12
31	28	157	4.9	8.5	18	75	3.2*	3.2*	3.2*	2.8	11.5	AHW31-12	Arm: OPAR-12
32	29	126	4.7	8.4	18	75	3.2*	3.2*	2.9	0.7	11.5	ASW32-12	Arm: OPAR-12
32	29	162	4.9	8.5	18	75	3.2*	3.2*	3.2*	2.4	11.5	AHW32-12	Arm: OPAR-12
33	30	130	4.7	8.4	18	75	3.2*	3.2*	2.2	--	11.5	ASW33-12	Arm: OPAR-12
33	30	166	4.9	8.5	18	75	3.2*	3.2*	3.2*	1.7	11.5	AHW33-12	Arm: OPAR-12
34	31	134	4.4	8.4	18	75	3.2*	3.2*	1.8	--	11.5	ASW34-12	Arm: OPAR-12
34	31	170	4.9	8.5	18	75	3.2*	3.2*	3.2*	1.4	11.5	AHW34-12	Arm: OPAR-12
35	32	138	4.7	8.4	18	75	3.2*	2.9	1.4	--	11.5	ASW35-12	Arm: OPAR-12
35	32	173	4.9	8.5	18	75	3.2*	3.2*	3.2*	1.1	11.5	AHW35-12	Arm: OPAR-12
BREAKAWAY Round Tapered Anchor Base pole with TWO 12-foot Mast Arms @180°													
27	24	129	4.7	7.9	18	75	3.2*	1.6	0.5	--	11.5	ASW27-22	Arms: 2@ OPAR-12
27	24	160	4.9	8.0	18	75	3.2*	3.2*	2.1	--	11.5	AHW27-22	Arms: 2@ OPAR-12
28	25	132	4.7	8.0	18	75	2.9	1.4	0.4	--	11.5	ASW28-22	Arms: 2@ OPAR-12
28	25	164	4.9	8.2	18	75	3.2*	3.2*	1.9	--	11.5	AHW28-22	Arms: 2@ OPAR-12
29	26	136	4.7	8.2	18	75	2.7	1.3	--	--	11.5	ASW29-22	Arms: 2@ OPAR-12
29	26	168	4.9	8.3	18	75	3.2*	3.1	1.7	--	11.5	AHW29-22	Arms: 2@ OPAR-12
30	27	139	4.7	8.3	18	75	2.5	1.1	--	--	11.5	ASW30-22	Arms: 2@ OPAR-12
30	27	173	4.9	8.4	18	75	3.2*	2.9	1.6	--	11.5	AHW30-22	Arms: 2@ OPAR-12
31	28	142	4.7	8.3	18	75	1.9	0.7	--	--	11.5	ASW31-22	Arms: 2@ OPAR-12
31	28	177	4.9	8.5	18	75	3.2*	2.3	1.2	--	11.5	AHW31-22	Arms: 2@ OPAR-12
32	29	146	4.7	8.4	18	75	1.6	0.5	--	--	11.5	ASW32-22	Arms: 2@ OPAR-12
32	29	182	4.9	8.5	18	75	3.2*	2.0	0.9	--	11.5	AHW32-22	Arms: 2@ OPAR-12
33	30	186	4.9	8.5	18	75	2.9	1.4	--	--	11.5	ASW33-22	Arms: 2@ OPAR-12
34	31	190	4.9	8.5	18	75	2.6	1.1	--	--	11.5	AHW34-22	Arms: 2@ OPAR-12
35	32	193	4.9	8.5	18	75	2.2	0.8	--	--	11.5	AHW35-22	Arms: 2@ OPAR-12

ALL POLES LISTED ON THIS PAGE HAVE BEEN ACCEPTED

PER THE 1985 AASHTO BREAKAWAY SPECIFICATIONS BY THE FEDERAL HIGHWAY ADMINISTRATION

■ Standard handhole: 2½" x 5" oval. Handhole covers are polyurethane coated to match pole color. ■ All poles are individually wrapped for shipment. ■ Poles on this page are predrilled for Shakespeare 12' Mast Arms. ■ Aluminum cap standard.

*Poles are not rated above 3.2 EPA because the mast arms are not rated for luminaires greater than 3.2 EPA each. EPA and weight specifications include the arm(s). All EPA recommendations are based on poles with handholes, and include a 30% gust factor.

Breakaway 12' Mast Arm Composite Tuff-Poles®

BAW, BBW, BCW, BHW, BSW and BXW Series Direct Burial Base

One or Two Shakespeare 12-foot Mast Arms



Nominal Mounting Height (ft.)	Shaft Length (ft.)	Pole Weight (lbs.)	POLE DIAMETER		Standard Handhole Location from Base (in.)	SUGGESTED MAXIMUM TOTAL LOADING PER ARM					Suggested Burial Depth (ft.)	BASIC CATALOG NUMBER	Comment
			Shaft Top (in.)	Shaft Base (in.)		Total Weight (lbs.)	80 MPH EPA* (sq. ft.)	90 MPH EPA* (sq. ft.)	100 MPH EPA* (sq. ft.)	120 MPH EPA* (sq. ft.)			
BREAKAWAY Round Tapered Direct Burial Base pole with ONE 12-foot Mast Arm													
20	21	77	4.6	7.3	66	75	3.2*	3.2*	3.2*	1.9	4	BHW24-12	Arm: OPAR-12
25	27	86	4.5	8.2	78	75	3.2*	1.8	0.6	--	5	BSW30-12	Arm: OPAR-12
25	27	111	4.7	8.3	78	75	3.2*	3.2*	3.2*	2.7	5	BHW30-12	Arm: OPAR-12
30	32	130	4.7	8.4	78	75	3.2*	3.2*	3.2*	1.4	5	BHW35-12	Arm: OPAR-12
35	38	164	6.2	11.3	90	75	3.2*	3.2*	2.1	--	6	BAW41-12	Arm: OPAR-12x6
35	38	223	6.4	11.4	90	75	3.2*	3.2*	3.2*	1.9	6	BBW41-12	Arm: OPAR-12x6
40	44	187	6.2	11.7	102	75	3.2*	1.9	--	--	7	BAW47-12	Arm: OPAR-12x6
40	44	255	6.4	11.8	102	75	3.2*	3.2*	1.3	--	7	BBW47-12	Arm: OPAR-12x6
40	44	295	6.6	11.9	102	75	3.2*	3.2*	3.2*	2.7	7	BCW47-12	Arm: OPAR-12x6
BREAKAWAY Round Tapered Direct Burial Base pole with TWO 12-foot Mast Arms @ 180°													
25	27	132	4.7	8.3	78	75	3.2*	2.6	1.3	--	5	BHW30-22	Arms: 2@ OPAR-12
25	27	164	4.9	8.4	78	75	3.2*	3.2*	2.6	0.5	5	BXW30-22	Arms: 2@ OPAR-12
30	32	185	4.9	8.5	78	75	3.2*	2.7	1.4	--	5	BXW35-22	Arms: 2@ OPAR-12
30	32	213	6.4	10.6	78	75	3.2*	3.2*	2.4	0.7	5	BBW35-22	Arms: 2@ OPAR-12x6
30	32	243	6.6	10.7	78	75	3.2*	3.2*	3.2*	2.0	5	BCW35-22	Arms: 2@ OPAR-12x6
35	38	245	6.4	11.4	90	75	3.2*	2.3	0.9	--	6	BBW41-22	Arms: 2@ OPAR-12x6
35	38	280	6.6	11.5	90	75	3.2*	3.2*	3.2*	0.6	6	BCW41-22	Arms: 2@ OPAR-12x6
40	44	277	6.4	11.8	102	75	2.6	1.0	--	--	7	BBW47-22	Arms: 2@ OPAR-12x6
40	44	317	6.6	11.9	102	75	3.2*	3.2*	1.8	--	7	BCW47-22	Arms: 2@ OPAR-12x6

**ALL POLES LISTED ON THIS PAGE HAVE BEEN ACCEPTED
PER THE 1985 AASHTO BREAKAWAY SPECIFICATIONS BY THE FEDERAL HIGHWAY ADMINISTRATION**

For EPA specifications for Breakaway poles without arms, see Breakaway Round Tapered Poles.

■ Standard handhole: 2½" x 5" oval. Optional 4" x 6" or 4" x 12" handholes, depending on pole dimensions. For other handhole options, contact factory. All handhole covers are polyurethane coated to match pole color. ■ All poles are individually wrapped for shipment. ■ Poles on this page are predrilled for Shakespeare 12' Mast Arms. ■ Aluminum cap and wiring access hole standard. ■ EPA and weight specifications include the arm(s). All EPA recommendations are based on poles with handholes, and include a 30% gust factor.

*Poles are not rated above 3.2 EPA because the mast arms are not rated for luminaires greater than 3.2 EPA each.

Breakaway Composite Tuff-Poles®
with 15' Mast Arms
Direct Burial Base

Breakaway Composite Tuff-Poles® with 15' Mast Arms

Direct Burial Base



BBW, and BCW Series
Breakaway Poles with
15' Mast Arm(s)

Direct Burial Base

- Mounting heights to 40'
- Natural or smooth finish
- No additional hardware or field assembly required for Breakaway poles
- Accepted per AASHTO Breakaway Specifications by the Federal Highway Administration
- Three standard and five special colors; architectural colors are available. Pigments and UV inhibitors integrated into the resin
- High-performance UV- and weather resistant pigmented polyurethane coating
- Capped construction.
- Poles are predrilled for Shakespeare 15' Truss Style Mast Arms
- Wiring access hole standard
- Poles are individually ID tagged
- Wrapped individually for shipment
- Direct Burial style for fast, easy installation and improved ground line appearance
- Anti-rotation flare structurally integrated into pole base during manufacture
- Shakespeare fiberglass won't rust, rot, or corrode in the ground, and insects won't eat it.
- No concrete foundations or anchor bolts

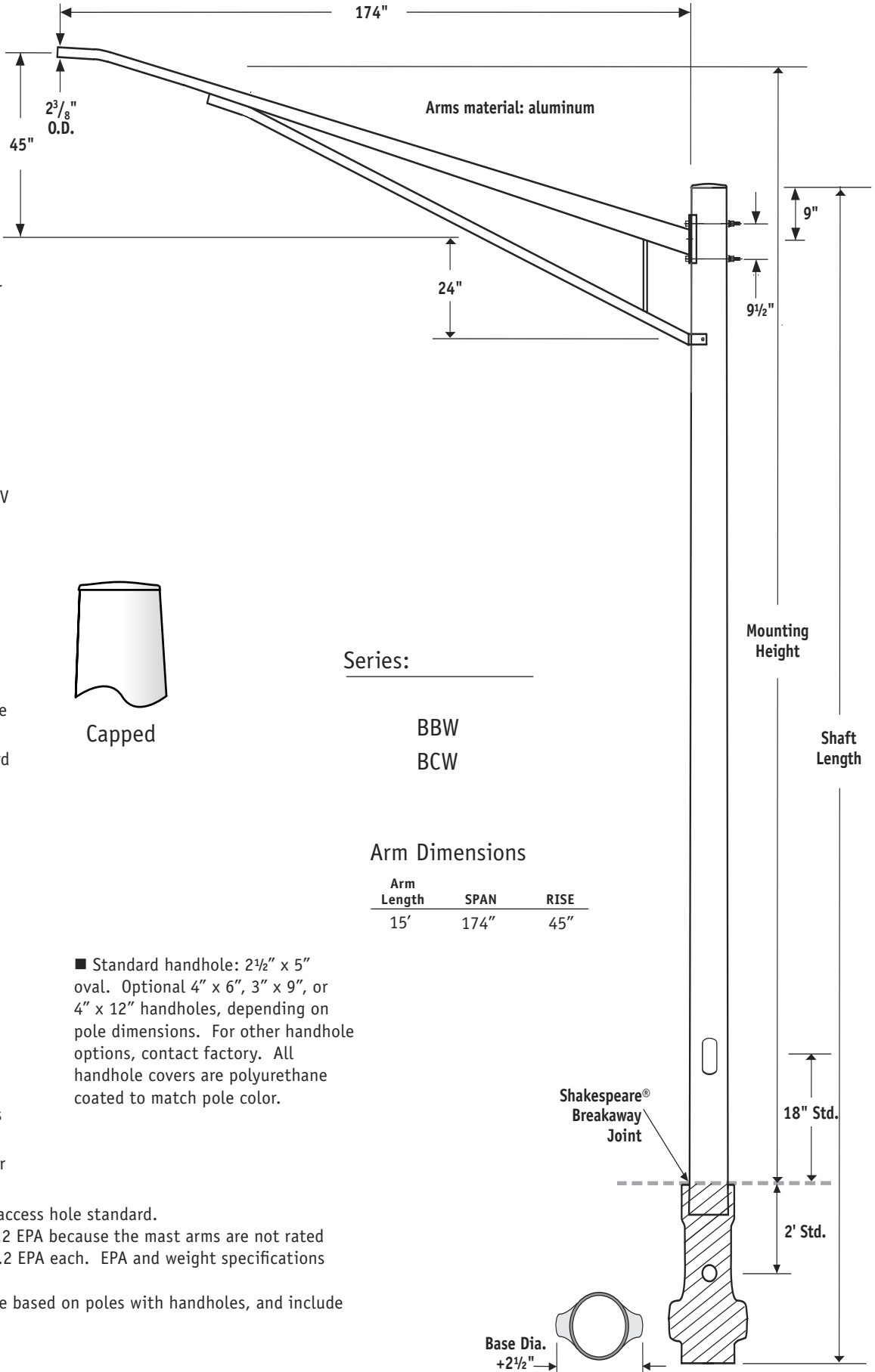

Series: _____

BBW
BCW

Arm Dimensions

Arm Length	SPAN	RISE
15'	174"	45"

- Standard handhole: 2 1/2" x 5" oval. Optional 4" x 6", 3" x 9", or 4" x 12" handholes, depending on pole dimensions. For other handhole options, contact factory. All handhole covers are polyurethane coated to match pole color.

■ Aluminum cap and wiring access hole standard.

*Poles are not rated above 3.2 EPA because the mast arms are not rated for luminaires greater than 3.2 EPA each. EPA and weight specifications include the arm(s).

*All EPA recommendations are based on poles with handholes, and include a 30% gust factor.

Breakaway 15' Mast Arm Composite Tuff-Poles®

BBW, and BCW Series Direct Burial Base

One or Two Shakespeare 15-foot Truss Style Mast Arms

**COMPOSITE
TUFF-POLE**

Nominal Mounting Height (ft.)	Shaft Length (ft.)	Pole Weight (lbs.)	POLE DIAMETER		Standard Handhole Location from Base (in.)	SUGGESTED MAXIMUM TOTAL LOADING PER ARM					Suggested Burial Depth (ft.)	BASIC CATALOG NUMBER	Comment
			Shaft Top (in.)	Shaft Base (in.)		Total Weight (lbs.)	80 MPH EPA* (sq. ft.)	90 MPH EPA* (sq. ft.)	100 MPH EPA* (sq. ft.)	120 MPH EPA* (sq. ft.)			
BREAKAWAY Round Tapered Direct Burial Base pole with ONE 15-foot Mast Arm													
25	27	183	6.4	9.9	78	75	3.2 *	3.2*	3.2*	2.9	5	BBW30-15	Arm: OPAR-15x6
30	32	209	6.4	10.6	78	75	3.2 *	3.2*	3.2*	0.9	5	BBW35-15	Arm: OPAR-15x6
35	38	241	6.4	11.4	90	75	3.2 *	3.2*	2.6	--	6	BBW41-15	Arm: OPAR-15x6
35	38	277	6.6	11.5	90	75	3.2 *	3.2*	3.2*	1.9	6	BCW41-15	Arm: OPAR-15x6
40	44	273	6.4	11.8	102	75	3.2 *	2.9	--	--	7	BBW47-15	Arm: OPAR-15x6
40	44	313	6.6	11.9	102	75	3.2 *	3.2*	3.2*	--	7	BCW47-15	Arm: OPAR-15x6
BREAKAWAY Round Tapered Direct Burial Base pole with TWO 15-foot Mast Arms @ 180°													
25	27	223	6.4	9.9	78	75	3.2 *	2.5	0.7	--	5	BBW30-25	Arms: 2@ OPAR-15x6
25	27	248	6.6	10.0	78	75	3.2 *	3.2*	3.2*	--	5	BCW30-25	Arms: 2@ OPAR-15x6
30	32	279	6.6	10.7	78	75	3.2 *	3.2*	2.1	--	5	BCW35-25	Arms: 2@ OPAR-15x6
35	38	317	6.6	11.5	90	75	3.2 *	2.1	--	--	6	BCW41-25	Arms: 2@ OPAR-15x6
40	44	353	6.6	11.9	102	75	3.0	0.5	--	--	7	BCW47-25	Arms: 2@ OPAR-15x6

**ALL POLES LISTED ON THIS PAGE HAVE BEEN ACCEPTED
PER THE 1985 AASHTO BREAKAWAY SPECIFICATIONS BY THE FEDERAL HIGHWAY ADMINISTRATION**

For EPA specifications for Breakaway poles without arms, see Breakaway Round Tapered Poles.

■ Standard handhole: 2½" x 5" oval. Optional 4" x 6" or 4" x 12" handholes, depending on pole dimensions. For other handhole options, contact factory. All handhole covers are polyurethane coated to match pole color. ■ All poles are individually wrapped for shipment. ■ Poles on this page are predrilled for Shakespeare 15' Truss Style Mast Arms. ■ Aluminum cap and wiring access hole standard. ■ EPA and weight specifications include the arm(s). All EPA recommendations are based on poles with handholes, and include a 30% gust factor.

*Poles are not rated above 3.2 EPA because the mast arms are not rated for luminaires greater than 3.2 EPA each.



Notes:





Shakespeare Composite Structures is a Philips Group Brand.

19845 U.S. Highway 76, Newberry, South Carolina 29108 · www.skp-cs.com · 800.800.9008 · 803.276.5504 · F/803.276.8940